

JVC

SERVICE MANUAL

AUDIO/VIDEO CONTROL RECEIVER

RX-5000VBK RX-5001VGD

Area Suffix

UF China
US Singapore

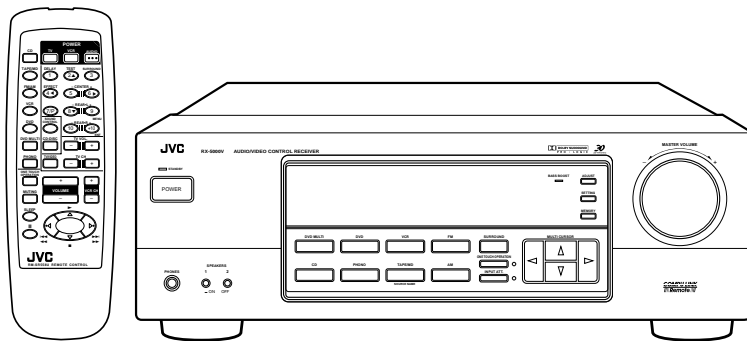

COMPU LINK
Remote

3D
3D-PHONIC

DOLBY SURROUND
PRO • LOGIC

Contents

Safety precautions	1-2	Description of major ICs	1-6
Disassembly method	1-3	Internal connections for	
Adjustment method	1-5	FL display tube	1-15

Safety Precautions

1. This design of this product contains special hardware and many circuits and components specially for safety purposes. For continued protection, no changes should be made to the original design unless authorized in writing by the manufacturer. Replacement parts must be identical to those used in the original circuits. Services should be performed by qualified personnel only.
2. Alterations of the design or circuitry of the product should not be made. Any design alterations of the product should not be made. Any design alterations or additions will void the manufacturer's warranty and will further relieve the manufacture of responsibility for personal injury or property damage resulting therefrom.
3. Many electrical and mechanical parts in the products have special safety-related characteristics. These characteristics are often not evident from visual inspection nor can the protection afforded by them necessarily be obtained by using replacement components rated for higher voltage, wattage, etc. Replacement parts which have these special safety characteristics are identified in the Parts List of Service Manual. Electrical components having such features are identified by shading on the schematics and by (Δ) on the Parts List in the Service Manual. The use of a substitute replacement which does not have the same safety characteristics as the recommended replacement parts shown in the Parts List of Service Manual may create shock, fire, or other hazards.
4. The leads in the products are routed and dressed with ties, clamps, tubings, barriers and the like to be separated from live parts, high temperature parts, moving parts and/or sharp edges for the prevention of electric shock and fire hazard. When service is required, the original lead routing and dress should be observed, and it should be confirmed that they have been returned to normal, after re-assembling.
5. Leakage current check (Electrical shock hazard testing)
After re-assembling the product, always perform an isolation check on the exposed metal parts of the product (antenna terminals, knobs, metal cabinet, screw heads, headphone jack, control shafts, etc.) to be sure the product is safe to operate without danger of electrical shock. Do not use a line isolation transformer during this check.

- Plug the AC line cord directly into the AC outlet. Using a "Leakage Current Tester", measure the leakage current from each exposed metal parts of the cabinet, particularly any exposed metal part having a return path to the chassis, to a known good earth ground. Any leakage current must not exceed 0.5mA AC (r.m.s.)

- Alternate check method

Plug the AC line cord directly into the AC outlet. Use an AC voltmeter having, 1,000 ohms per volt or more sensitivity in the following manner. Connect a 1,500 Ω 10W resistor paralleled by a 0.15 μ F AC-type capacitor between an exposed metal part and a known good earth ground.

Measure the AC voltage across the resistor with the AC voltmeter.

Move the resistor connection to each exposed metal part, particularly any exposed metal part having a return path to the chassis, and measure the AC voltage across the resistor. Now, reverse the plug in the AC outlet and repeat each measurement. voltage measured Any must not exceed 0.75 V AC (r.m.s.). This corresponds to 0.5 mA AC (r.m.s.).

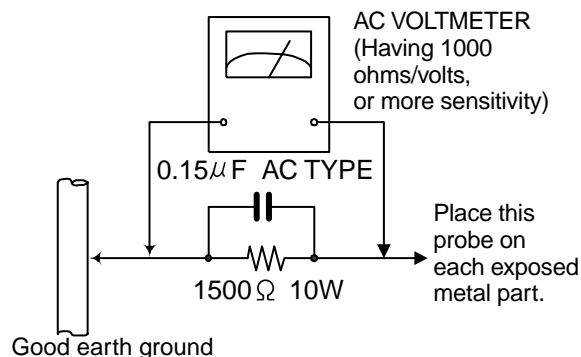

Warning

1. This equipment has been designed and manufactured to meet international safety standards.
2. It is the legal responsibility of the repairer to ensure that these safety standards are maintained.
3. Repairs must be made in accordance with the relevant safety standards.
4. It is essential that safety critical components are replaced by approved parts.
5. If mains voltage selector is provided, check setting for local voltage.

CAUTION Burrs formed during molding may be left over on some parts of the chassis. Therefore, pay attention to such burrs in the case of performing repair of this system.

Disassembly method

■ Removing the top cover (See Fig.1)

1. Remove 4 screws "A" on both sides of the top cover and 3 screws "B" on the rear side.
2. Lift the back of the top cover spreading both sides to remove.

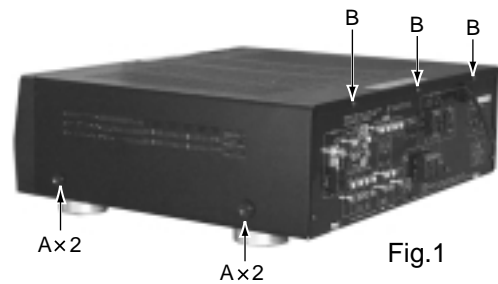

■ Removing the front panel assembly (See Fig.2,3)

1. Remove the top cover.
2. Remove 4 screws "C" on the bottom side and 3 screws "D" on the top side.
3. Disconnect the wire CN811 on the main board.
4. Disconnect the wire CN314 on the audio & source selector board.
5. Remove the front panel assembly.

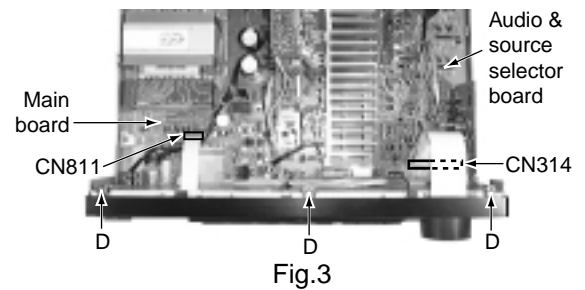
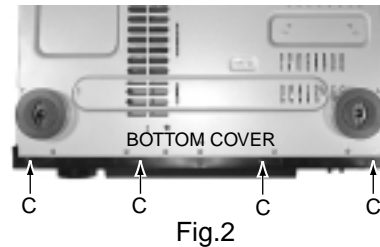

■ Removing the rear panel (See Fig.4)

1. Remove the top cover.
2. Remove 21 screws "E" on the rear panel.
3. Remove 3 screws "F" on the rear panel.
4. Remove the power cord stopper up side.
5. Remove the rear panel.

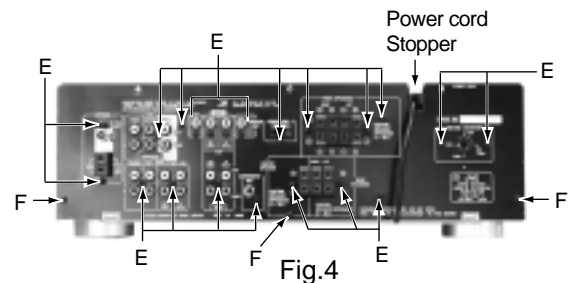

■ Removing the tuner board and video board (See Fig.5)

1. Remove the rear panel.
2. Remove 1 screw "G" on the video board
3. Disconnect the connector CN311 on the video board
4. Disconnect the connector CN111 on the audio & source selector board.

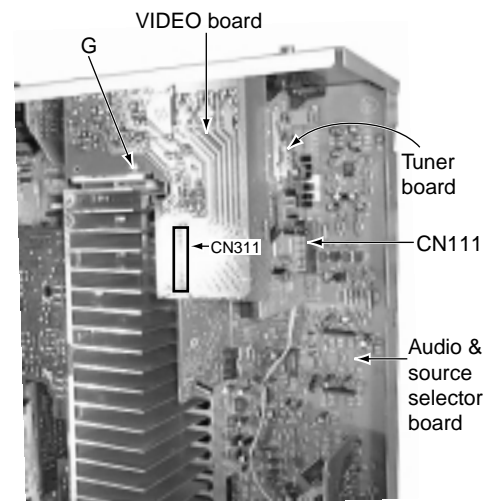
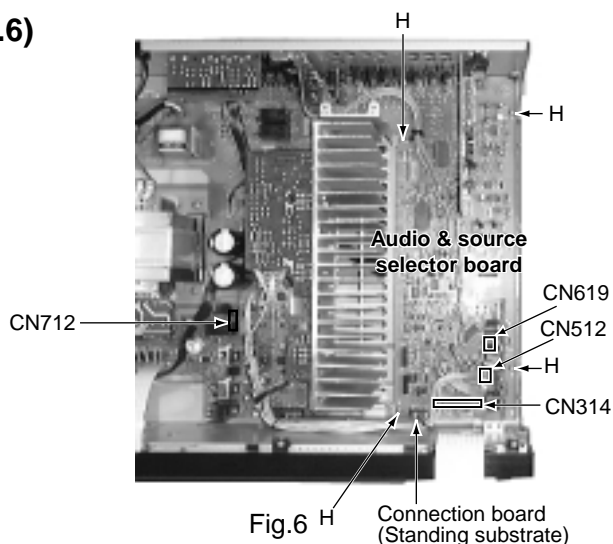

Fig.5

■ Removing the audio & source selector board (See Fig.6)

1. Remove the rear panel.
2. Remove the video board and Tuner board.
3. Disconnect the connector CN512 and CN619 on the audio & source selector board.
4. Disconnect to the card wire CN314 on the audio & source selector board.
5. Disconnect the connector CN712 on the AMP board.
6. Each tie band is cut out.
7. Pullout the connection board.
8. Remove 4 screws "H" on the audio & source selector board.
9. Remove the audio & source selector board.



■ Removing the main board (See Fig.6 to 8)

1. Remove the rear panel and front panel assembly.
2. Pull out the pre AMP board and connection board.
3. Remove 8 screws "I" on the main board.
4. Remove 8 screws "J" on the power transistor.
5. Disconnect the connector CN511 and wire CN831 on the main board.
6. Each tie band is cut out.
7. Remove 2 screws "K" on push switch of the front side.
8. Remove nut on terminal of the headphone.
9. The solder of the wire connected with the transformer is removed.
10. Remove the main board.

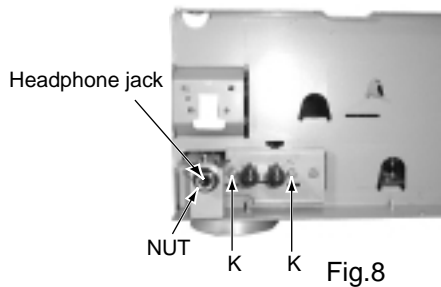
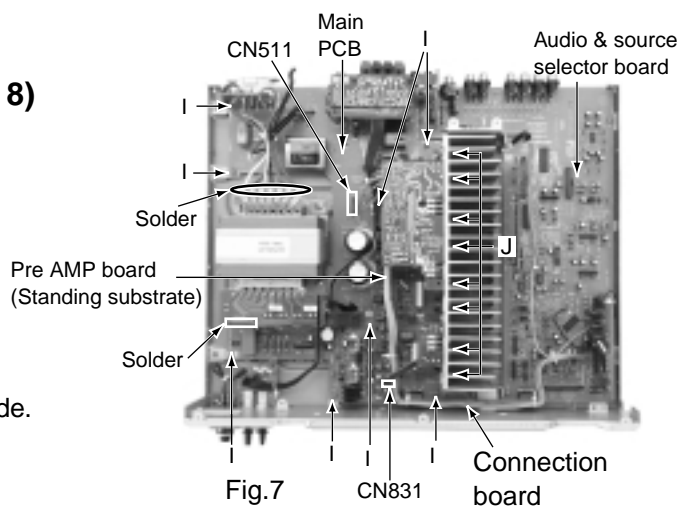

■ Removing the front board (See Fig.9)

1. Remove the top cover.
2. Remove the Front panel assembly.
3. Remove the master volume knob and nut.
4. Remove the 13 screws "L" on the Front board.

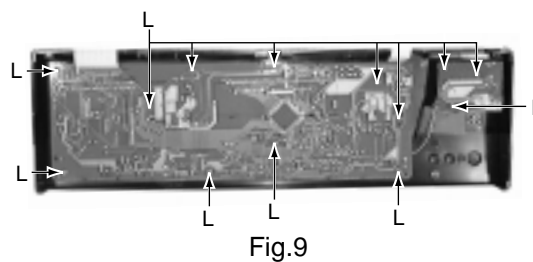

Adjustment method

■ TUNER SECTION

1. Tuner range

FM	87.5MHz~108.0MHz
AM(MW)	530kHz~1710kHz

■ POWER AMPLIFIER SECTION

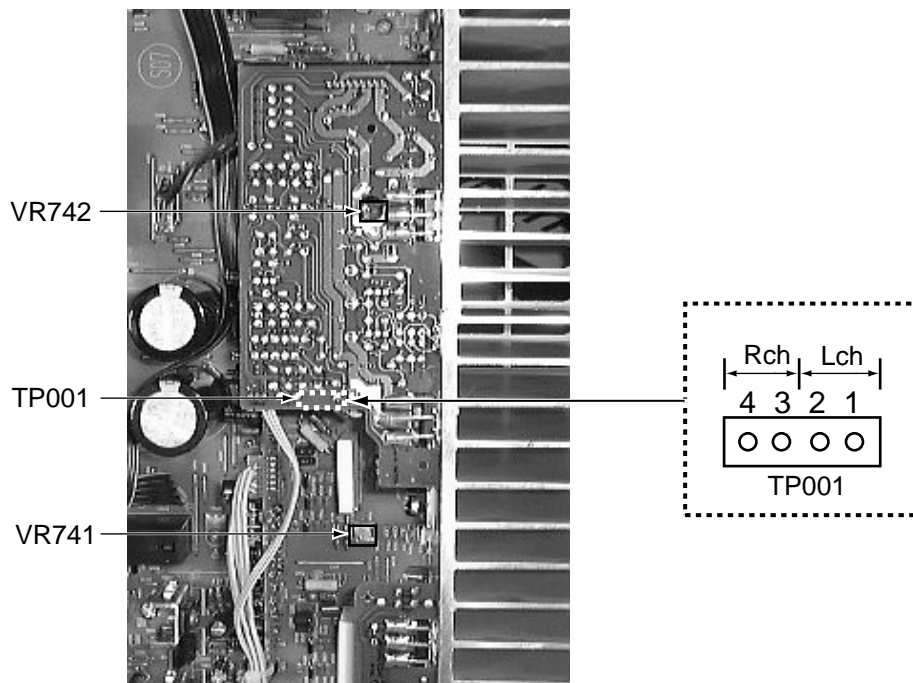

IDLING CURRENT

1. Set the volume control to minimum during this adjustment.
2. Set the surround mode OFF.
2. Turn VR741 and VR742 fully counterclockwise to warm up before adjustment.
If the heat sink is already warm from previous use the correct adjustment can not be made.
3. For L-ch, connect a DC voltmeter between TP001's pin1 and pin2 (Lch)
And, connect it between pin3 and pin4(Rch).
4. 30 minutes later after power on, adjust VR741 for L-ch, or VR742 for R-ch so that the DC voltmeter value has 1mV~10mV.

Description of major ICs

■ M62446FP(IC341) : 6CH Master volume

1. Block Diagram

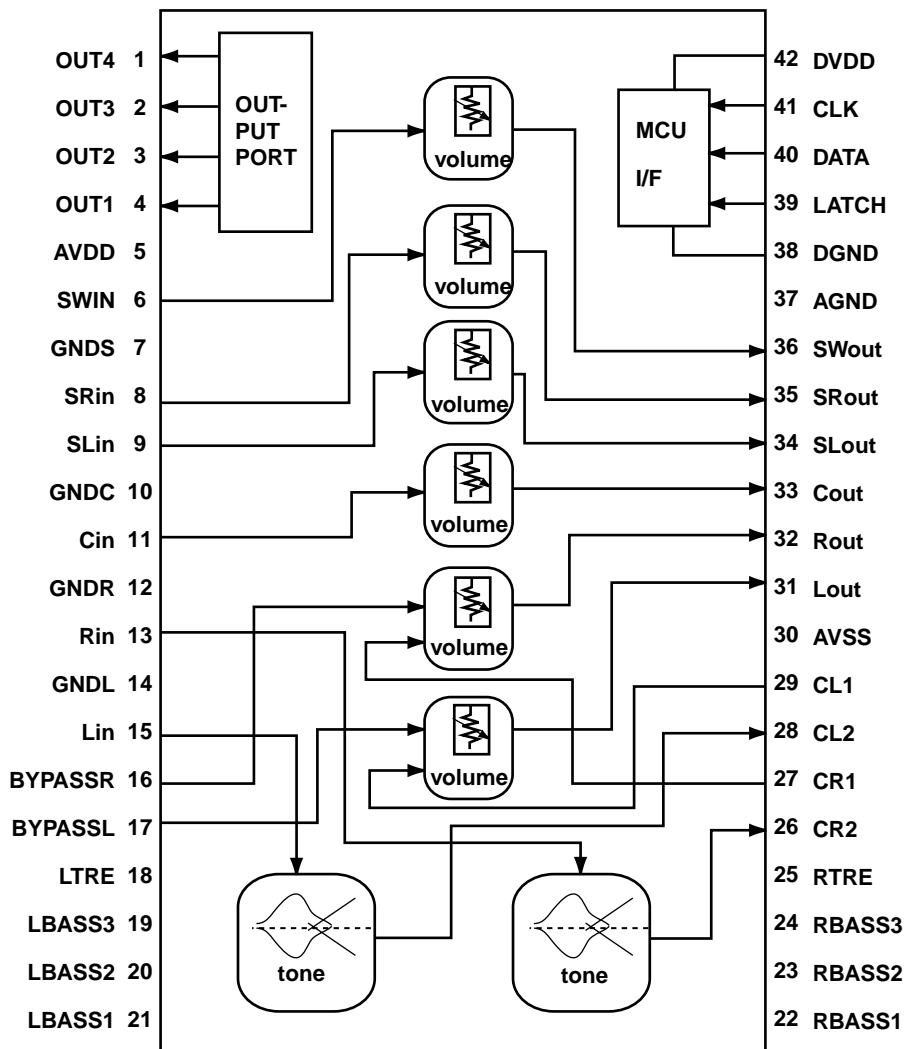

2.Pin Function

Pin No.	Symbol	I/O	Descriptions
1	SURROUND	O	SURROUND control terminal
2	BASS BOOST	O	BASS BOOST control terminal
3	INPUT-ATT	O	Input attenuator control terminal
4	MUTING	O	MUTING control terminal
5	AVDD	-	Analog positive power supply terminal
6	SWIN	I	SUB Woofer volume signal input terminal
7	A.GND	-	Analog ground terminal
8	RR IN	I	R ch volume signal input terminal for rear speaker
9	RL IN	I	L ch volume signal input terminal for rear speaker
10	A.GND	-	Analog ground terminal
11	C IN	I	Center volume signal input terminal
12	A.GND	-	Analog ground terminal
13	R IN	I	R ch volume signal input terminal
14	A.GND	-	Analog ground terminal
15	L IN	I	L ch volume signal input terminal
16,17		-	Non connect
18		-	Frequency adjustment terminal tone/treble
19~21		-	Frequency adjustment terminal tone/bass
22		O	Tone output terminal
23,24		-	Frequency adjustment terminal tone/bass
25		-	Frequency adjustment terminal tone/treble
26		-	Frequency adjustment terminal tone/bass
27		I	L/R volume input terminal
28		O	Tone output terminal
29		I	L/R volume input terminal
30	AVSS	-	Analog negative power supply terminal
31	L OUT	O	L ch output
32	R OUT	O	R ch output
33	C OUT	O	Center volume signal output terminal
34	RL OUT	O	L ch volume signal output terminal for rear speaker
35	RR OUT	O	R ch volume signal output terminal for rear speaker
36	SW OUT	O	SUB Woofer volume signal output terminal
37	A.GND	-	Analog ground terminal
38	D.GND	-	Digital ground terminal
39	VOL STB	I	Latch input terminal
40	VOL DATA	I	Volume data input terminal
41	VOL CLK	I	Clock input terminal for data transfer
42	DVDD	-	Digital power supply terminal

■ LA1838(IC102): FM AM IF AMP&detector, FM MPX Decoder

1. Block Diagram

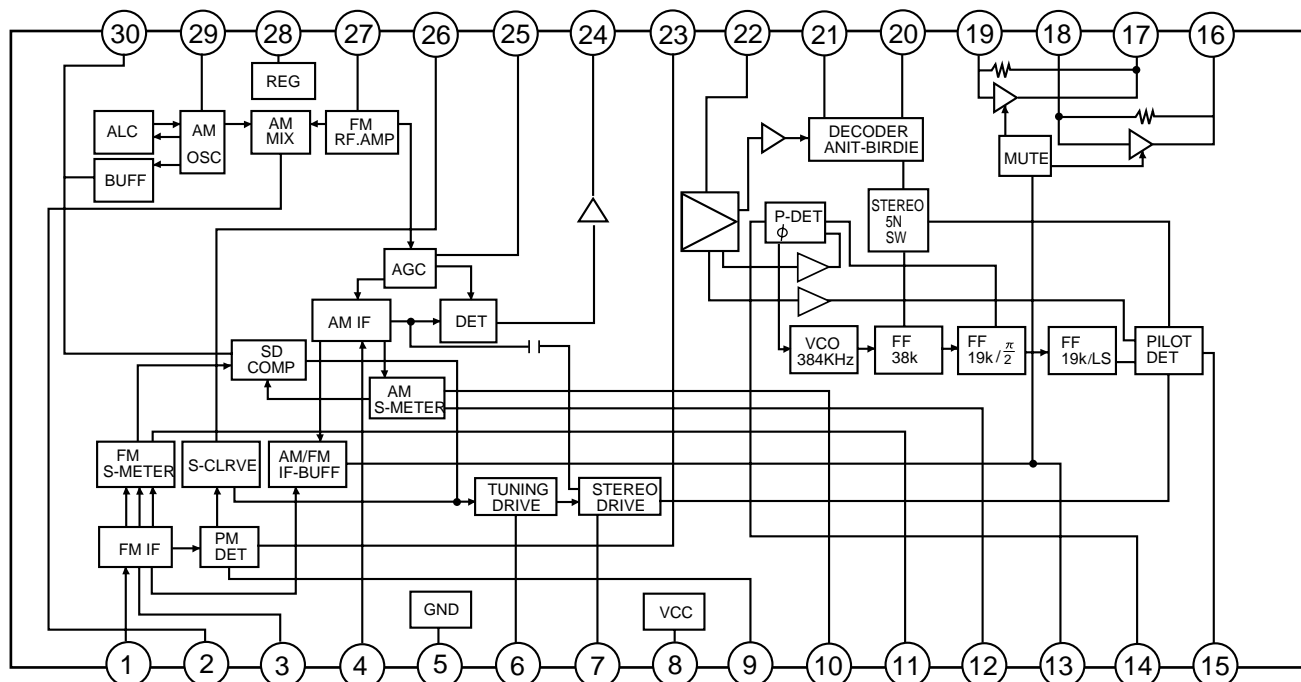

2. Pin Function

Pin No.	Symbol	I/O	Function	Pin No.	Symbol	I/O	Function
1	FM IN	I	This is an input terminal of FM IF signal.	16	R OUT	O	Right channel signal output.
2	AM MIX	O	This is an out put terminal for AM mixer.	17	L OUT	O	Left channel signal output.
3	FM IF	I	Bypass of FM IF	18	R IN	I	Input terminal of the Right channel post AMP.
4	AM IF	I	Input of AM IF Signal.	19	L IN	I	Input terminal of the Left channel post AMP.
5	GND	-	This is the device ground terminal.	20	RO	O	Mpx Right channel signal output.
6	TUNED	O	When the set is tuning,this terminal becomes "L".	21	LO	O	Mpx Left channel signal output.
7	STEREO	O	Stereo indicator output. Stereo "L", Mono: "H"	22	IF IN	I	Mpx input terminal
8	VCC	-	This is the power supply terminal.	23	FM OUT	O	FM detection output.
9	FM DET	-	FM detect transformer.	24	AM DET	O	AM detection output.
10	AM SD	-	This is a terminal of AM ceramic filter.	25	AM AGC	I	This is an AGC voltage input terminal for AM
11	FM VSM	O	Adjust FM SD sensitivity.	26	AFC	-	This is an output terminal of voltage for FM-AFC.
12	AM VSM	O	Adjust AM SD sensitivity.	27	AM RF	I	AM RF signal input.
13	MUTE	I/O	When the signal of IF REQ of IC121(LC72131) appear, the signal of FM/AM IF output. //Muting control input.	28	REG	O	Register value between pin 26 and pin28 besides the frequency width of the input signal.
14	FM/AM	I	Change over the FM/AM input. "H" :FM, "L" : AM	29	AM OSC	-	This is a terminal of AM Local oscillation circuit.
15	MONO/ST	O	Stereo : "H", Mono: "L"	30	OSC BUFFER	O	AM Local oscillation Signal output.

■ LC72136N (IC121) : PLL Frequency Synthesizer

1. Pin layout

XT	1	22	XT
FM/AM	2	21	GND
CE	3	20	LPFOUT
DI	4	19	LPFIN
CLOCK	5	18	PD
DO	6	17	VCC
FM/ST/VCO	7	16	FMIN
AM/FM	8	15	AMIN
	9	14	
	10	13	IFCONT
SDIN	11	12	IFIN

2. Block diagram

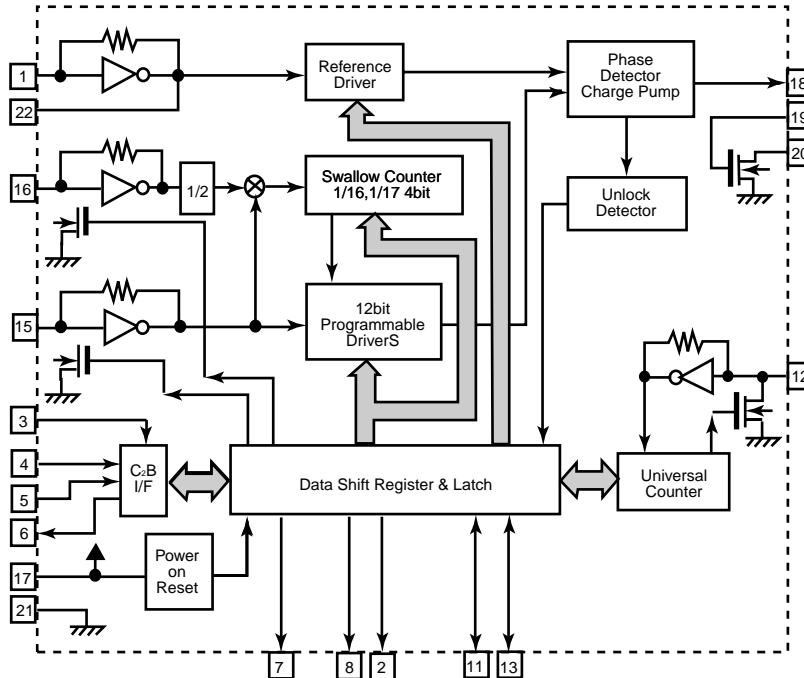

3. Pin function

Pin No.	Symbol	I/O	Function	Pin No.	Symbol	I/O	Function
1	XT	I	X'tal oscillator connect (75kHz)	12	IFIN	I	IF counter signal input
2	FM/AM	O	LOW:FM mode	13	IFCONT	O	IF signal output
3	CE	I	When data output/input for 4pin(input) and 6pin(output): H	14		-	Not use
4	DI	I	Input for receive the serial data from controller	15	AMIN	I	AM Local OSC signal output
5	CLOCK	I	Sync signal input use	16	FMIN	I	FM Local OSC signal input
6	DO	O	Data output for Controller Output port	17	VCC	-	Power supply(VDD=4.5-5.5V) When power ON:Reset circuit move
7	FM/ST/VCO	O	"Low": MW mode	18	PD	O	PLL charge pump output(H: Local OSC frequency Height than Reference frequency. L: Low Agreement: Height impedance)
8	AM/FM	O	Open state after the power on reset	19	LPFIN	I	Input for active lowpassfilter of PLL
9	LW	I/O	Input/output port	20	LPFOUT	O	Output for active lowpassfilter of PLL
10	MW	I/O	Input/output port	21	GND	-	Connected to GND
11	SDIN	I/O	Data input/output	22	XT	I	X'tal oscillator(75KHz)

■ MN173222BA(IC401) : System controller

1.Key Matrix

	KEY OUT 0	KEY OUT1	KEY OUT 2	KEY OUT 3	KEY OUT 4
KEY IN 0	POWER	SURROUND	DVD MULTI	←	CD
KEY IN 1	ADJUST	ONE TOUCH OPERATION	DVD	→	PHONE
KEY IN 2	SETTING	INPUT ATT	VCR	↑	TAPE/MD
KEY IN 3	MEMORY	—	FM	↓	AM

2.Pin Function (1/2)

Pin No.	Symbol	I/O	Function
1,2	IN1,2	I	Volume jog signal input
3,4	VIDEO1,2	O	Video signal switch output
5	PROTECT	I	Protect signal input of speaker
6	POWER	O	Power ON output
7~10	KI0~3	I	Key matrix signal input
11	VCR /S/C	-	Not used
12~21	G11~G2	O	FL grid signal output
22	G1/KO7	O	FL grid signal output / Key matrix signal output
23	VPP	-	Power supply
24~39	S1~16	O	FL segment control signal output
40	B.BOOST LED	O	Bass boost indicator control
41	CLK.D	O	Clock signal output to DSP
42	DATAIN.D	I	Data signal input from DSP
43	DATAOUT.D	O	Data signal output to DSP
44	INH	I	Inhibit detection signal input
45	RDS CLK	I	Clock signal input from RDS
46	RDS DATA	I	Data input from RDS
47	SW DATA	O	Function switch data signal output
48	REMOCON IN	I	Remote control signal input
49	RDS D.ST	I	Data start signal for block data to output serial data
50	STEREO	I	Stereo indicator output. Stereo "L" Mono "H"
51	TUNED	I	When the set is tuning, this terminal becomes "L"
52	CE.PLL	O	Chip enable output to IC121
53	CK.PLL	I/O	Clock signal for IC121
54	SW.CLK	O	Function switch clock signal output
55	DO.PLL	I/O	Tuner PLL data
56	DCS IN	I	Compulink signal input
57	DCS OUT	O	Compulink signal output
58	ERR.DSP	I	DSP control data input
59	IFOK.DSP	I	DSP control data input
60	ACK.DSP	I	DSP control data input
61	CD.DSP	O	DSP control data output
62	RELAY Sch	O	Rear ch relay control signal output
63	T.MUTE	O	TUNER mute signal output
64	SUBWFMUTE	O	Sub woofer mute signal output

2.Pin Function (2/2)

Pin No.	Symbol	I/O	Function
65	TV OUT	-	Connect to GND
66	VCR OUT	-	Connect to GND
67	VCR IN	-	
68	RESET IN	I	Reset signal input
69	X1	-	Connect to GND
70	X2	-	Non connect
71	VSS	-	Connect to GND
72	OSC2	-	Oscillation terminal
73	OSC1	-	Oscillation terminal
74	VDD	-	Power supply
75	RELAY Cch	O	Center ch relay control signal output
76	RELAY L/R	O	Front ch relay control signal output
77	SURROUND	O	Surround ON/OFF control
78	INPUT ATT LED	O	INPUT ATT. Indicator control
79	ONE T. LED	O	ONE TOUCH OPERATION indicator control
80	STANDBY LED	O	STANDBY indicator control
81	STB-SW	O	Strobe signal output of function switch
82	VOLUME DATA	O	Data output to IC341
83	VOLUME CLK	O	Clock signal output to IC341
84	VOLUMESTB	O	Strobe signal output to IC341

■ NJM2246D(IC201):Video Switch

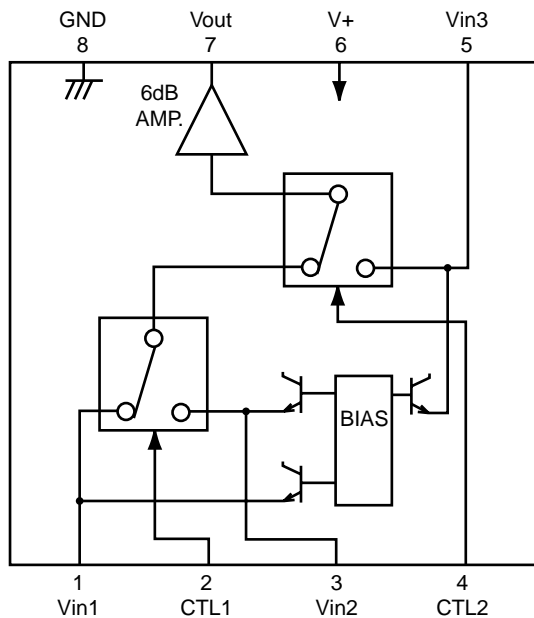

Control input - output signal

CTL 1	CTL 2	Output
L	L	VIN 1
H	L	VIN 2
L/H	H	VIN 3

■ TC9471F(IC601) : Dolby prologic

1. Block Diagram

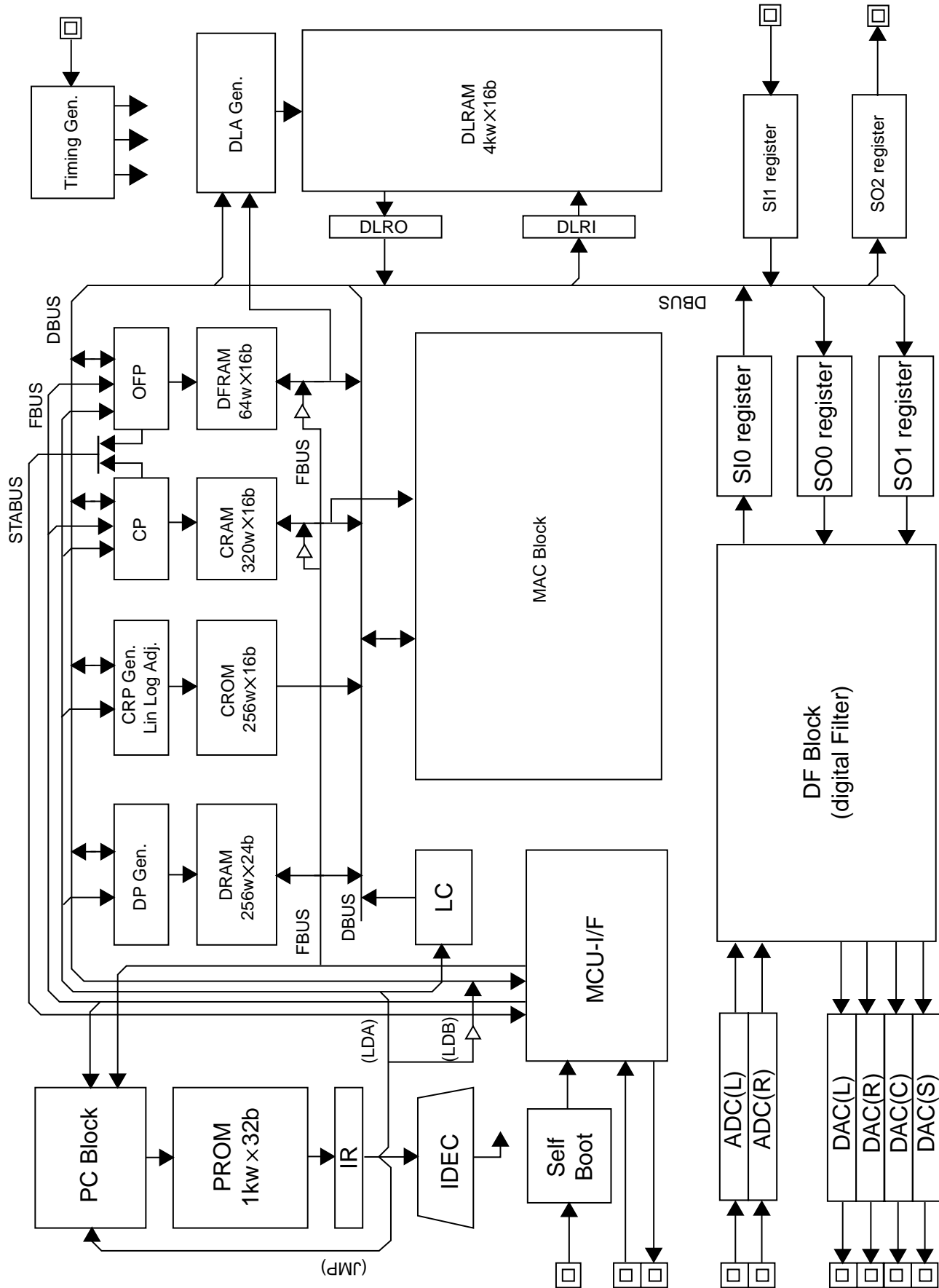

2.Pin Function (1/2)

Pin No.	Symbol	I/O	Function
1	ECKO	-	Non connect
2	ECKI	I	Amplifier input terminal for external clock input.
3	A.GND	-	Ground terminal.(For crystal oscillator circuit)
4	A.GND	-	Ground terminal.(For DAC L channel)
5	LchOUT	O	DAC analog signal output terminal.(L channel)
6	V-REF1	-	Reference voltage terminal.(For DAC L channel)
7	A.5V	-	Power supply terminal.(For DAC L channel)
8	A.5V	-	Power supply terminal.(For DAC R channel)
9	V-REF2	-	Reference voltage terminal.(For DAC R channel)
10	RchOUT	O	DAC analog signal output terminal.(R channel)
11	A.GND	-	Ground terminal.(For DAC R channel)
12	A.GND	-	Ground terminal.(For DAC C channel)
13	N.C	O	DAC analog signal output terminal.(C channel)
14	CchOUT	O	DAC analog signal output terminal with attenuator.(For C channel)
15	V-REF3	-	Reference voltage terminal.(For DAC C channel)
16	A.5V	-	Power supply terminal.(For DAC C channel)
17	VRO	O	Reference voltage terminal for attenuator.(Output buffer)
18	VRI	I	Reference voltage terminal for attenuator.(Input buffer)
19	A.5V	-	Power supply terminal.(For DAC S channel)
20	V-REF4	-	Reference voltage terminal.(For DAC S channel)
21	SchOUT	O	DAC analog signal output terminal with attenuator.(For S channel)
22	NC	-	Non connect.
23	A.GND	-	Ground terminal.(For DAC S channel)
24	D.GND	-	Ground terminal.
25~29	NC	-	Non connect.
30	D.5V	-	Power supply terminal.
31	D.5V	-	Power supply terminal.(For DLRAM)
32	D.GND	-	Ground terminal.(For DLRAM)
33~43	NC	-	Non connect.
44	D.GND	-	Ground terminal.
45.46	NC	-	Non connect.
47	D.5V	-	Power supply terminal.
48~53	NC	-	Non connect.
54		-	Ground terminal.
55		-	Power supply.
56		-	Ground terminal.
57	RESET	I	Power supply.

2.Pin Function (2/2)

Pin No.	Symbol	I/O	Function
58	D.5V	-	Power supply terminal
59~71		-	Non connect.
72	DSP-CS	I	Chip select signal input terminal.(MCU interface)
73	DSP-CLK	I	Data sift clock input terminal.(MCU interface)
74	DATA-IN	I/O	Data input terminal.(MCU interface) At the IC bus mode,data input /output terminal.
75	DATA-OUT	O	Data output terminal.(MCU interface) At the IC bus mode,normally open.
76	DSP-IFOK	O	Operation flag output terminal.(MCU interface)
77	DSP-ACK	O	Acknowledge signal output terminal.(MCU interface)
78	DSP-ERR	O	Error flag output terminal.(MCU interface)
79	I2CS	I	IC bus mode select terminal.
80	BOOT	I	Self-boot control terminal.
81,82			Non connect.
83	D.5V	-	Power supply terminal.
84~87		-	Ground terminal.
88	D.GND	-	Digital ground terminal.(For ADC L channel)
89	A.GND	-	Analog ground terminal.(For ADC L channel)
90	LchIN	I	ADC analog signal input terminal.(L channel)
91	V-REF5	-	Reference voltage terminal.(For ADC L channel)
92,93	A.5V	-	Analog power supply terminal.
94	V-REF6	-	Reference voltage terminal.(For ADC R channel)
95	RchIN	-	ADC analog signal input terminal.(R channel)
96,97	A.GND	-	Analog ground terminal.(For ADC R channel)
98	XI	I	Crystal oscillator connection terminal.(input)
99	XO	O	Crystal oscillator connection terminal.(output)
100	A.5V	-	Power supply terminal.(For crystal oscillator circuit)

Block diagrams

■ Amplifier/Control section

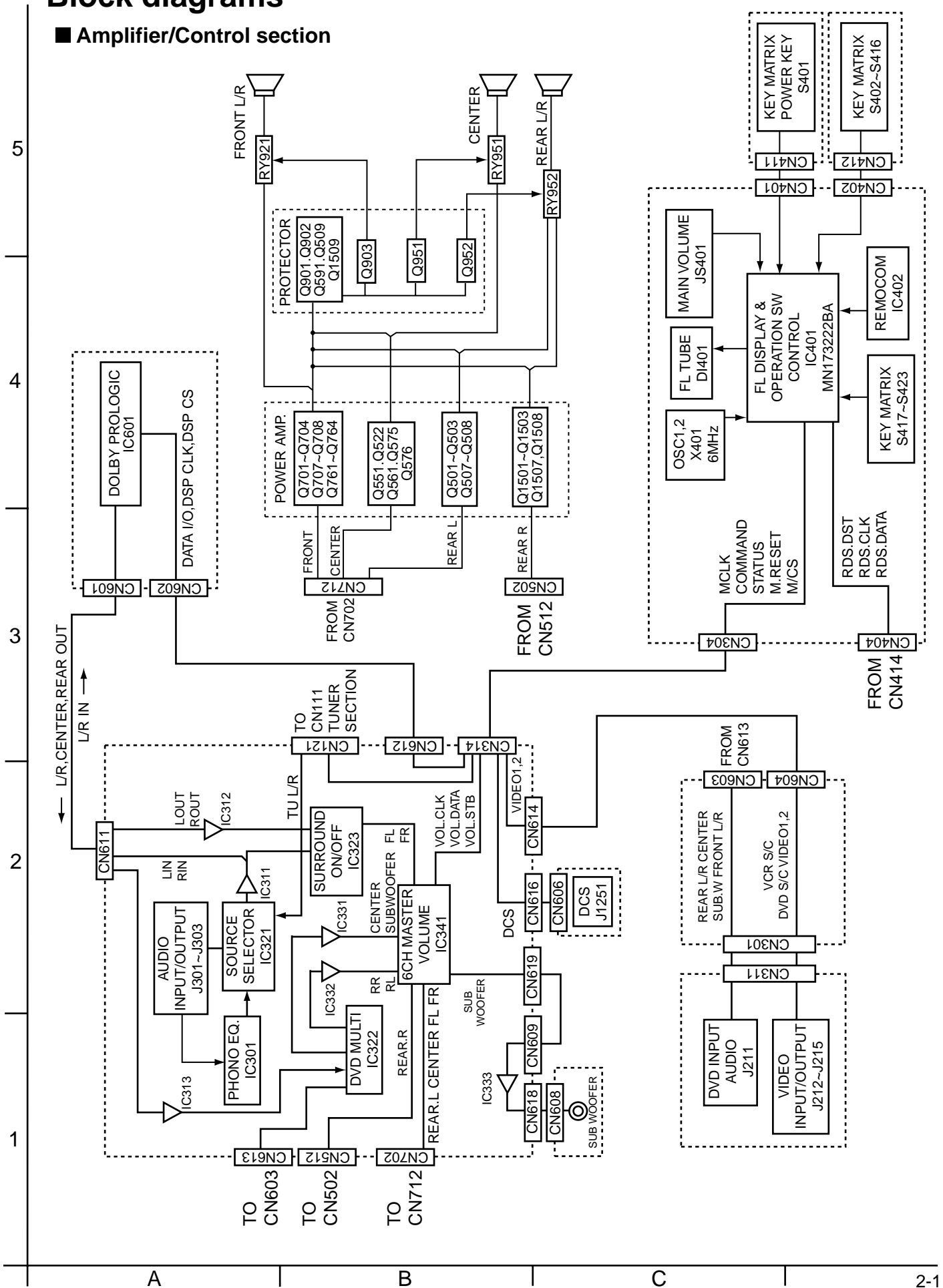

■ Tuner Section

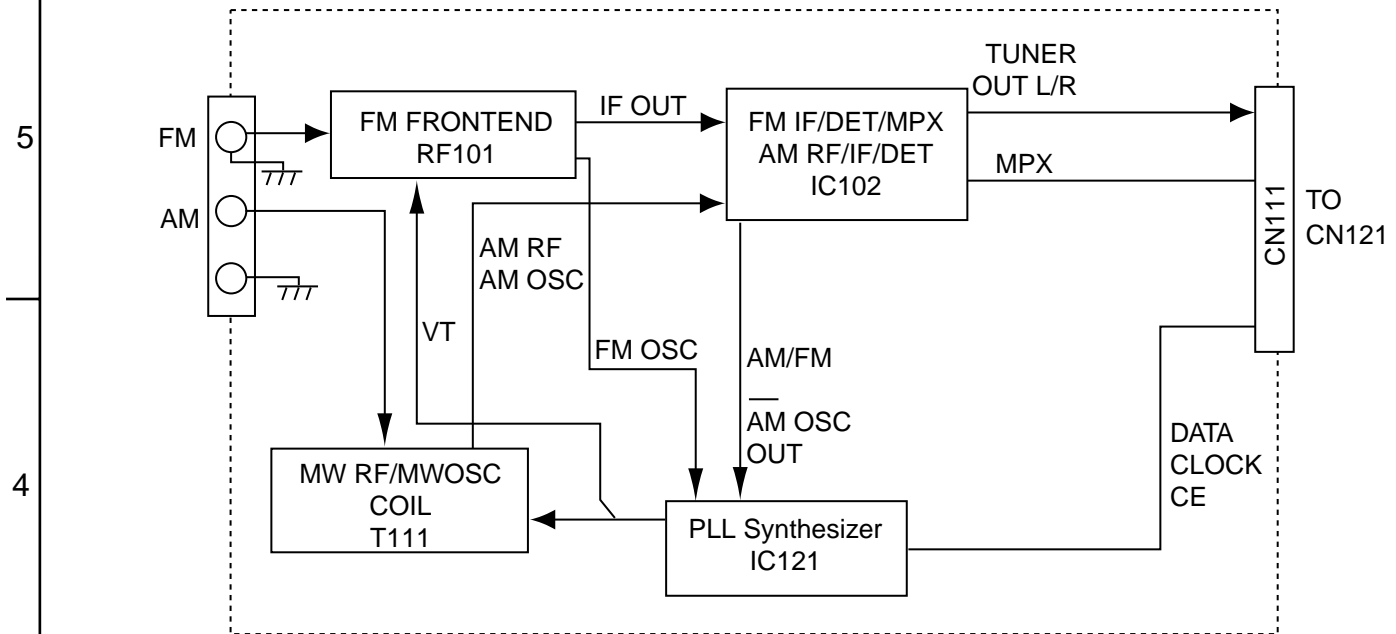

■ Power Supply Section

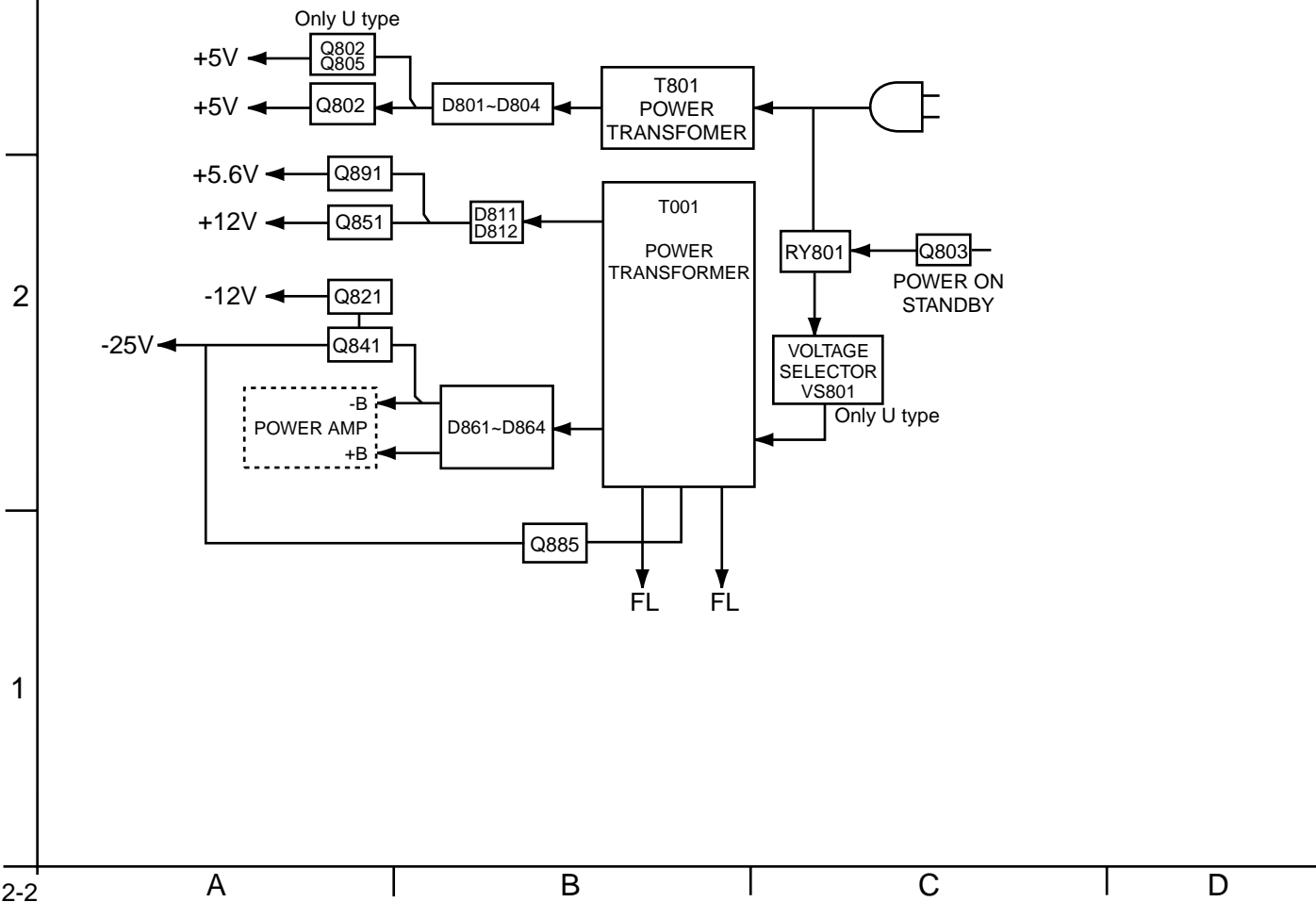

Standard schematic diagrams

Power supply section

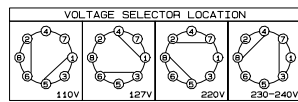
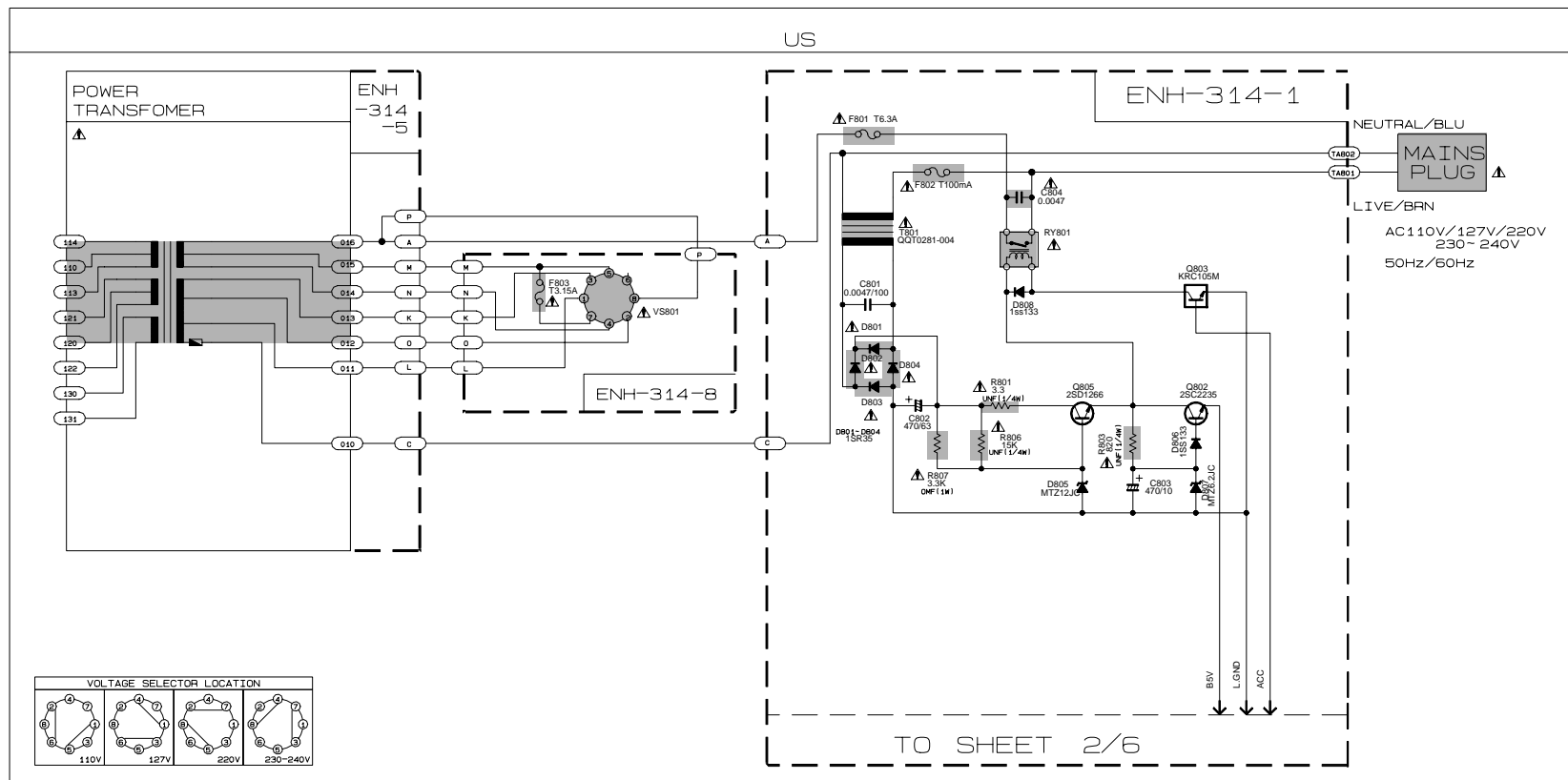
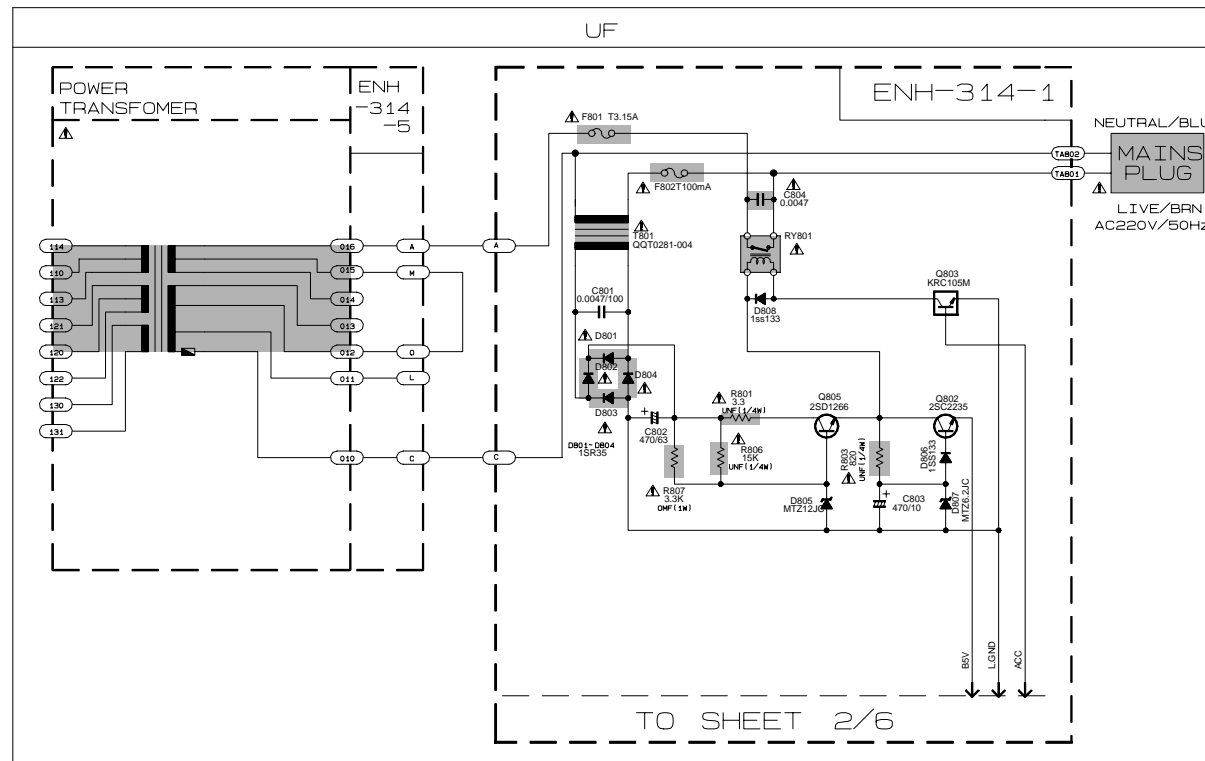

VERSION CODES
US : SINGAPORE
UF : CHINA

NOTES:
 MARK(*) IS TO SHOW DEVIATION IN VERSIONS.
 DETAILS ARE EXPLAINED NEAR THE MARK.

EXPLANATION OF OVERALL OF SCHEMA.
MODEL RX-5000VBK/RX-5001VGD

SHEET NUMBER	CIRCUIT DESCRIPTION
1/6	PRIMARY
2/6	RECTIFIER/REGULATOR /AUDIO AMP./SPEAKER TERMINAL
3/6	AUDIO SIGNAL INPUT TERMINAL /SOURCE SELECT IC /FRONT REAR CENTER VOLUME
4/6	AUDIO VIDEO SIGNAL INPUT TERMINAL /SOURCE SELECT IC
5/6	USER CONTROL KEYS/SYSTEMCONTROL LSI /FL DISPLAY
6/6	SURROUND IC

MODEL
 RX-5000VBK/5001VGD

Parts are safety assurance parts.
 When replacing those parts make sure to use the specified.

Audio AMP / Power primary section

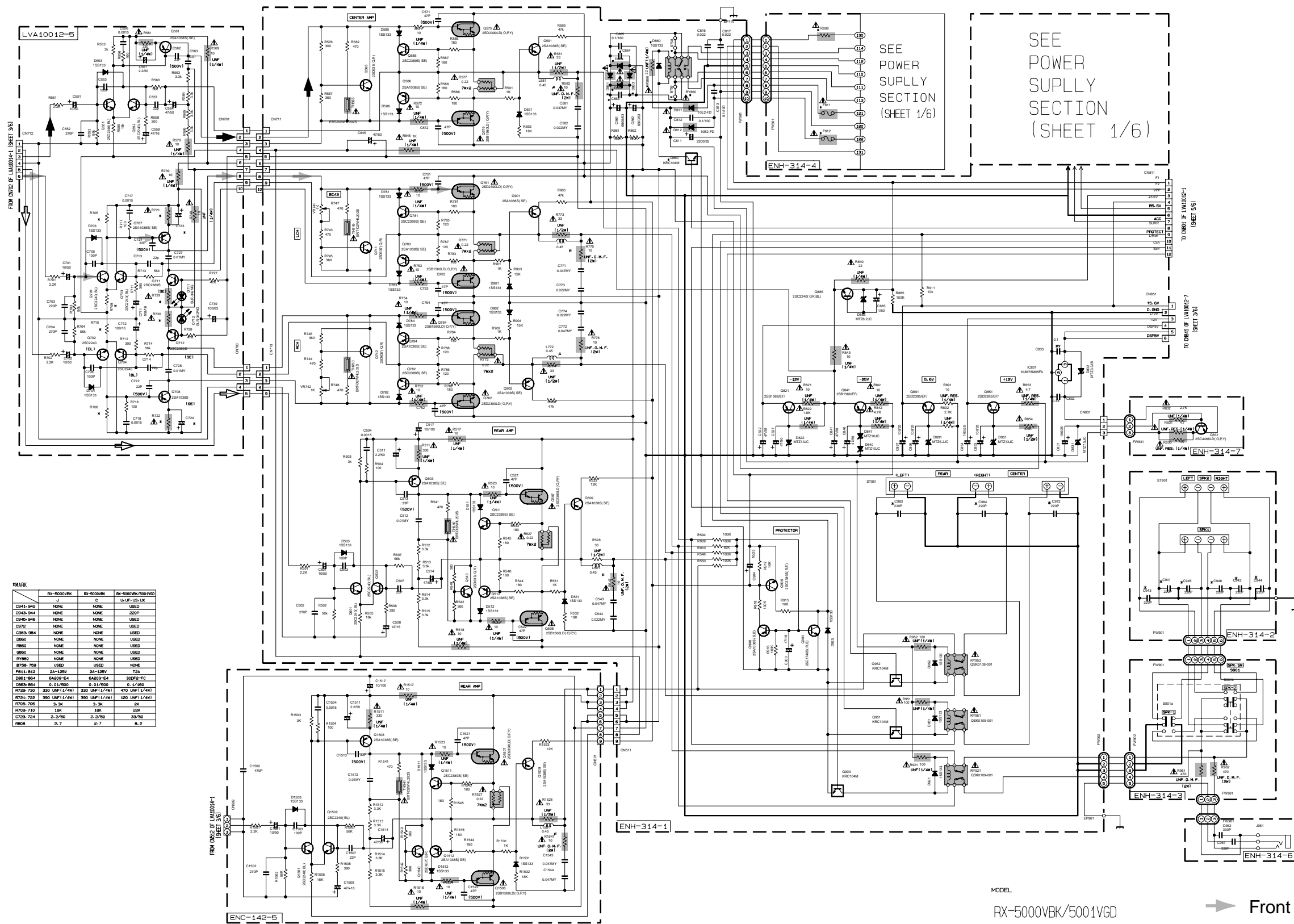

*MARK

	RX-5000VBK	RX-5000VGD	RX-5000VBK/5001VGD
C843-844	NONE	NONE	USED
C845-846	NONE	NONE	USED
C872	NONE	NONE	USED
C883-884	NONE	NONE	USED
D883	NONE	NONE	USED
R883	NONE	NONE	USED
R884	NONE	NONE	USED
R885	NONE	NONE	USED
R886	NONE	NONE	USED
R887	NONE	NONE	USED
R888	NONE	NONE	USED
R889	NONE	NONE	USED
R890	NONE	NONE	USED
R891	NONE	NONE	USED
R892	NONE	NONE	USED
R893	NONE	NONE	USED
R894	NONE	NONE	USED
R895	NONE	NONE	USED
R896	NONE	NONE	USED
R897	NONE	NONE	USED
R898	NONE	NONE	USED
R899	NONE	NONE	USED
R900	NONE	NONE	USED
R901	NONE	NONE	USED
R902	NONE	NONE	USED
R903	NONE	NONE	USED
R904	NONE	NONE	USED
R905	NONE	NONE	USED
R906	NONE	NONE	USED
R907	NONE	NONE	USED
R908	NONE	NONE	USED
R909	NONE	NONE	USED
R910	NONE	NONE	USED
R911	NONE	NONE	USED
R912	NONE	NONE	USED
R913	NONE	NONE	USED
R914	NONE	NONE	USED
R915	NONE	NONE	USED
R916	NONE	NONE	USED
R917	NONE	NONE	USED
R918	NONE	NONE	USED
R919	NONE	NONE	USED
R920	NONE	NONE	USED
R921	NONE	NONE	USED
R922	NONE	NONE	USED
R923	NONE	NONE	USED
R924	NONE	NONE	USED
R925	NONE	NONE	USED
R926	NONE	NONE	USED
R927	NONE	NONE	USED
R928	NONE	NONE	USED
R929	NONE	NONE	USED
R930	NONE	NONE	USED
R931	NONE	NONE	USED
R932	NONE	NONE	USED
R933	NONE	NONE	USED
R934	NONE	NONE	USED
R935	NONE	NONE	USED
R936	NONE	NONE	USED
R937	NONE	NONE	USED
R938	NONE	NONE	USED
R939	NONE	NONE	USED
R940	NONE	NONE	USED
R941	NONE	NONE	USED
R942	NONE	NONE	USED
R943	NONE	NONE	USED
R944	NONE	NONE	USED
R945	NONE	NONE	USED
R946	NONE	NONE	USED
R947	NONE	NONE	USED
R948	NONE	NONE	USED
R949	NONE	NONE	USED
R950	NONE	NONE	USED
R951	NONE	NONE	USED
R952	NONE	NONE	USED
R953	NONE	NONE	USED
R954	NONE	NONE	USED
R955	NONE	NONE	USED
R956	NONE	NONE	USED
R957	NONE	NONE	USED
R958	NONE	NONE	USED
R959	NONE	NONE	USED
R960	NONE	NONE	USED
R961	NONE	NONE	USED
R962	NONE	NONE	USED
R963	NONE	NONE	USED
R964	NONE	NONE	USED
R965	NONE	NONE	USED
R966	NONE	NONE	USED
R967	NONE	NONE	USED
R968	NONE	NONE	USED
R969	NONE	NONE	USED
R970	NONE	NONE	USED
R971	NONE	NONE	USED
R972	NONE	NONE	USED
R973	NONE	NONE	USED
R974	NONE	NONE	USED
R975	NONE	NONE	USED
R976	NONE	NONE	USED
R977	NONE	NONE	USED
R978	NONE	NONE	USED
R979	NONE	NONE	USED
R980	NONE	NONE	USED
R981	NONE	NONE	USED
R982	NONE	NONE	USED
R983	NONE	NONE	USED
R984	NONE	NONE	USED
R985	NONE	NONE	USED
R986	NONE	NONE	USED
R987	NONE	NONE	USED
R988	NONE	NONE	USED
R989	NONE	NONE	USED
R990	NONE	NONE	USED
R991	NONE	NONE	USED
R992	NONE	NONE	USED
R993	NONE	NONE	USED
R994	NONE	NONE	USED
R995	NONE	NONE	USED
R996	NONE	NONE	USED
R997	NONE	NONE	USED
R998	NONE	NONE	USED
R999	NONE	NONE	USED
R1000	NONE	NONE	USED

MODEL
RX-5000VBK/5001VGD

⚠ Parts are safety assurance parts. When replacing those parts make sure to use the specified.

- ➡ Front signal
- ➡ Surround Signal
- ➡ Center signal

■ Audio IN / OUT & Source selector section

5
4
3
2
1

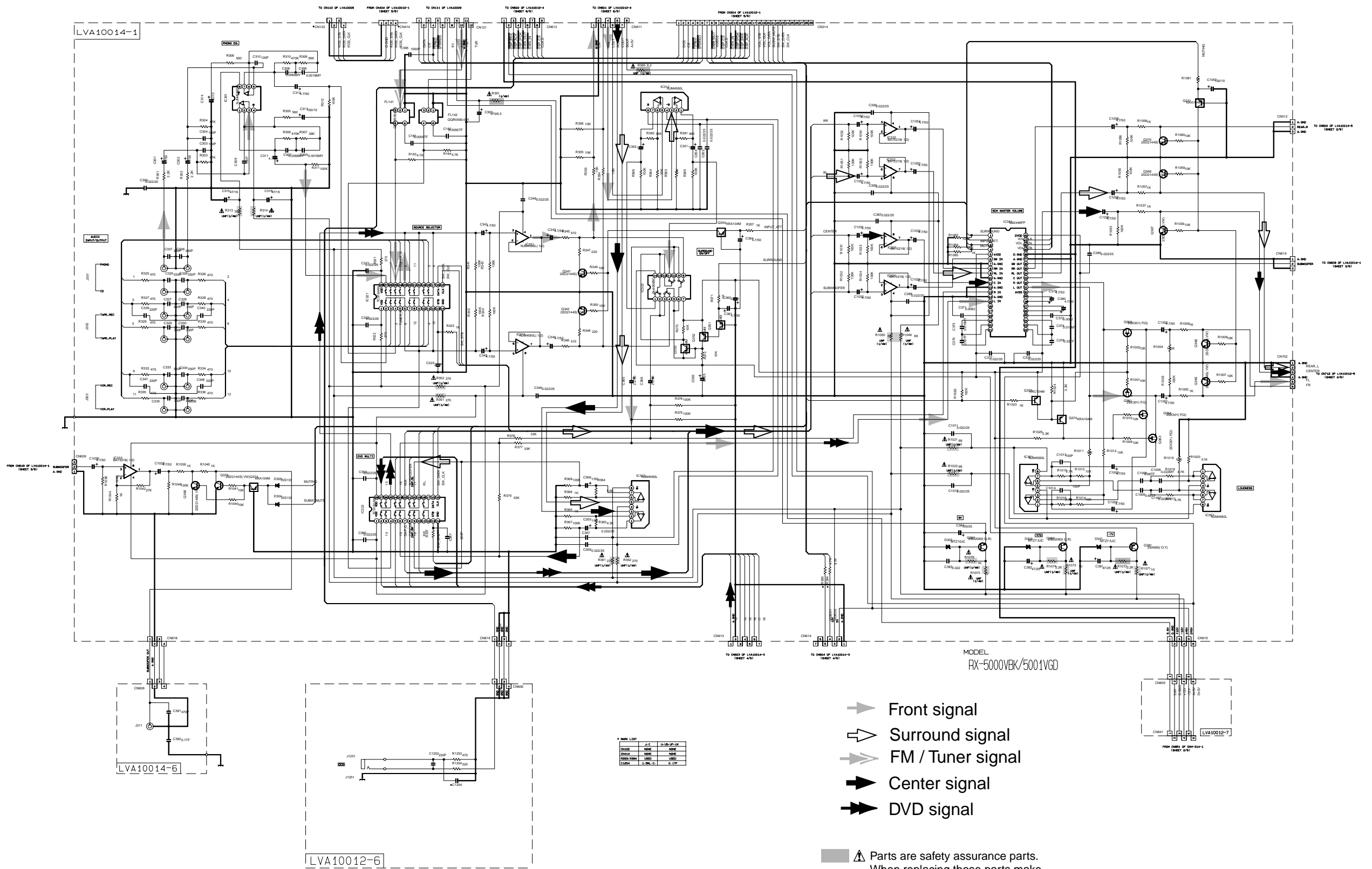

- ➔ Front signal
- ➔ Surround signal
- ➔ FM / Tuner signal
- ➔ Center signal
- ➔ DVD signal

⚠ Parts are safety assurance parts. When replacing those parts make sure to use the specified one.

◆ MARK LIST

MARK	QTY	UNIT	REMARK
C101	1	10K	10KΩ
C102	1	10K	10KΩ
C103	1	10K	10KΩ
C104	1	10K	10KΩ
C105	1	10K	10KΩ
C106	1	10K	10KΩ
C107	1	10K	10KΩ
C108	1	10K	10KΩ

System control & operation switch section

5
4
3
2
1

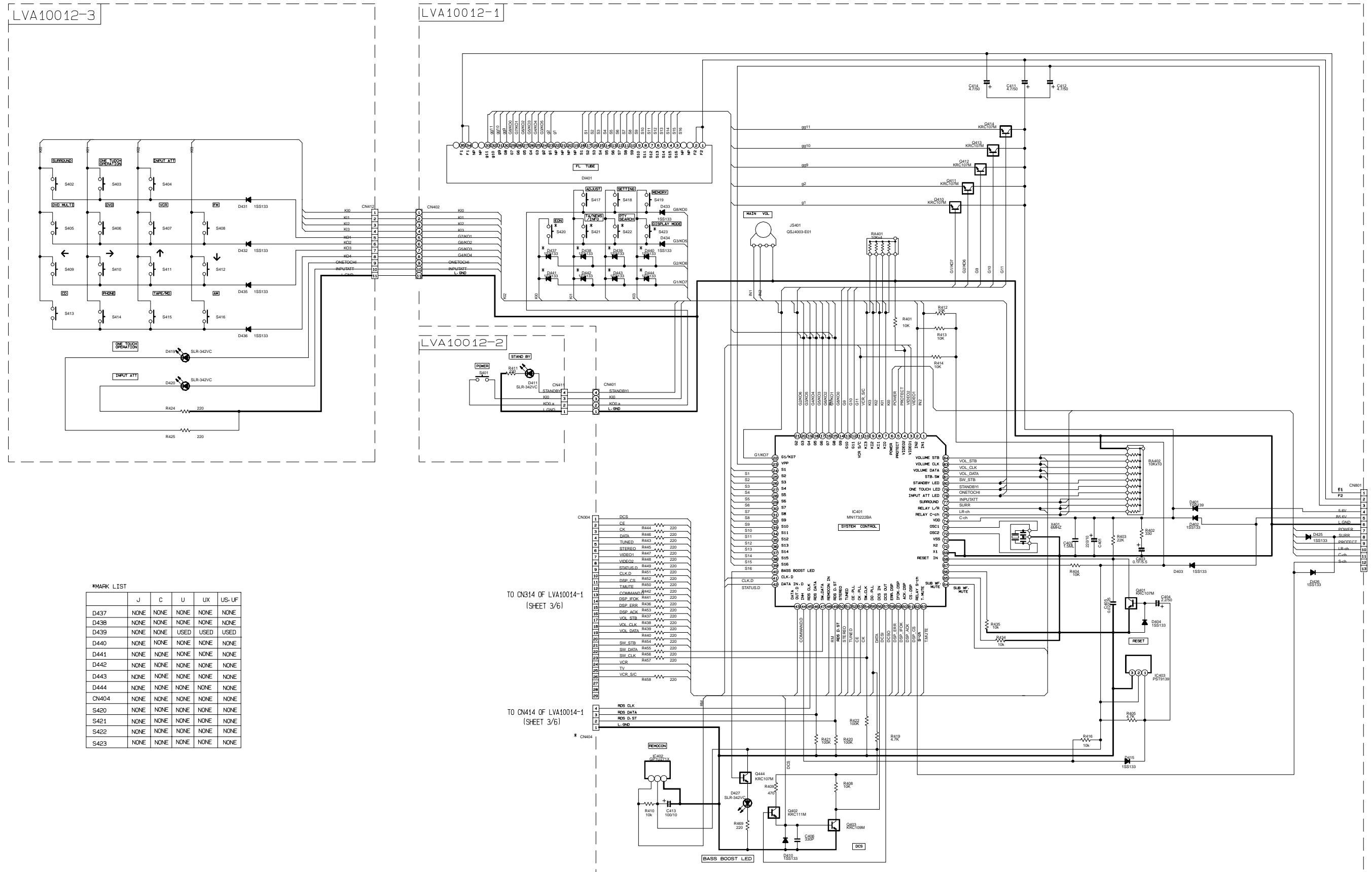

*MARK LIST

	J	C	U	LUX	US-UF
D437	NONE	NONE	NONE	NONE	NONE
D438	NONE	NONE	NONE	NONE	NONE
D439	NONE	NONE	USED	USED	USED
D440	NONE	NONE	NONE	NONE	NONE
D441	NONE	NONE	NONE	NONE	NONE
D442	NONE	NONE	NONE	NONE	NONE
D443	NONE	NONE	NONE	NONE	NONE
D444	NONE	NONE	NONE	NONE	NONE
CN404	NONE	NONE	NONE	NONE	NONE
S420	NONE	NONE	NONE	NONE	NONE
S421	NONE	NONE	NONE	NONE	NONE
S422	NONE	NONE	NONE	NONE	NONE
S423	NONE	NONE	NONE	NONE	NONE

TO CN314 OF LVA10014-1 (SHEET 3/6)

TO CN414 OF LVA10014-1 (SHEET 3/6)

FROM CN11 OF EN314-1 (SHEET 2/6)

■ DSP Control section

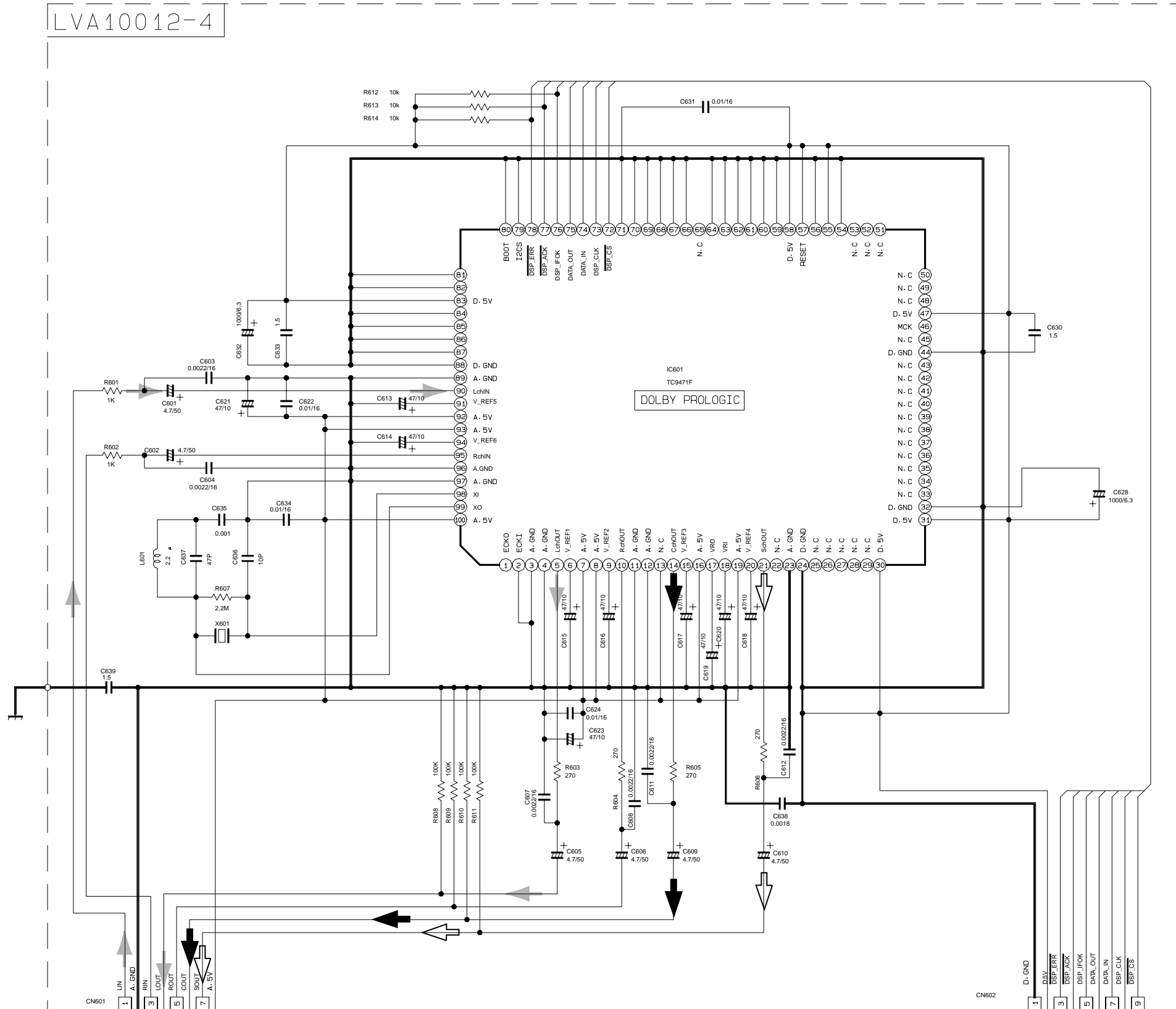

LVA10012-4

DOLBY PROLOGIC

MODEL
RX-5000VBK/5001VGD

FROM CN611 OF LVA10014-1
(SHEET 3/6)

FROM CN612 OF LVA10014-1
(SHEET 3/6)

- Front signal
- Surround Signal
- Center signal

5

4

3

2

1

A

B

C

2-8

D

E

F

G

H

■ Tuner section

FOR J, C, U, A
LVA10009

5
4
3
2
1

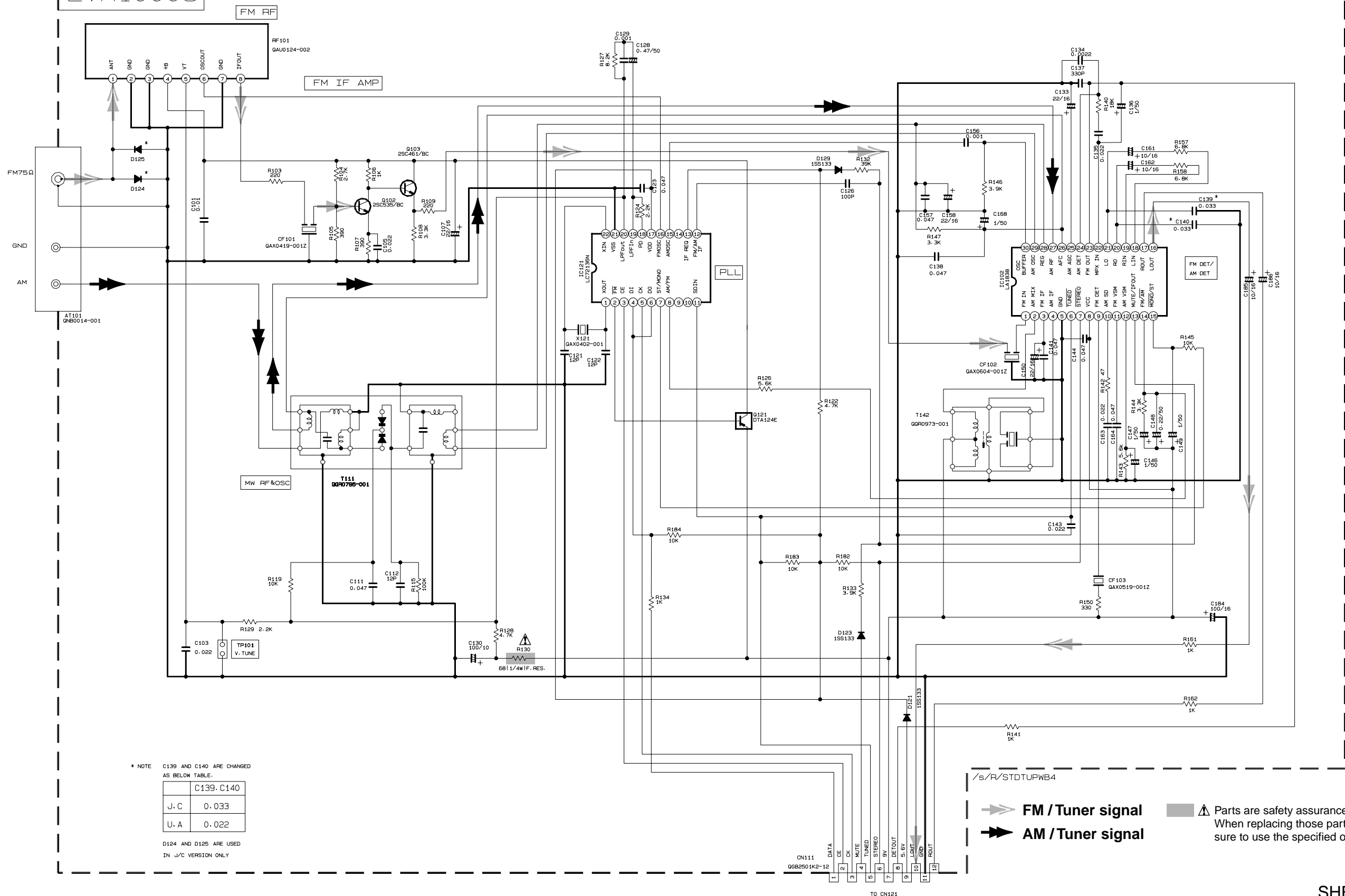

* NOTE C139 AND C140 ARE CHANGED AS BELOW TABLE.

	C139, C140
J, C	0.033
U, A	0.022

D124 AND D125 ARE USED IN J/C VERSION ONLY

/s/R/STDTPWB4

➤ FM / Tuner signal

➡ AM / Tuner signal

⚠ Parts are safety assurance parts. When replacing those parts make sure to use the specified one.



SHEET END

Printed circuit boards

■ System control & DSP board

5

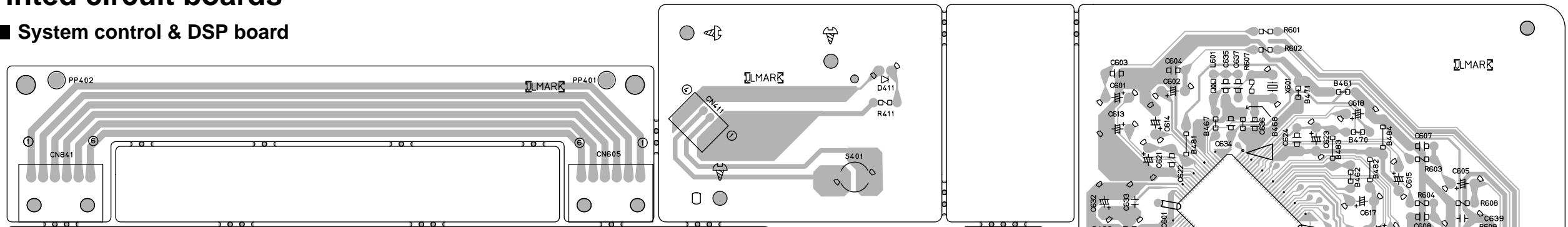

4

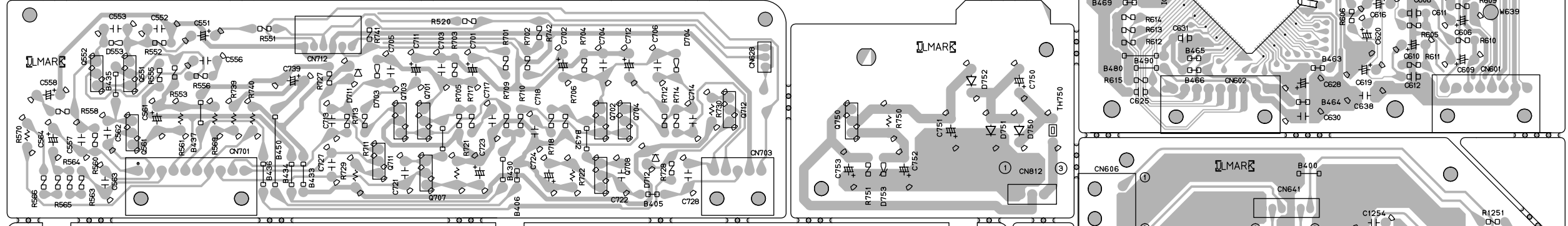

3

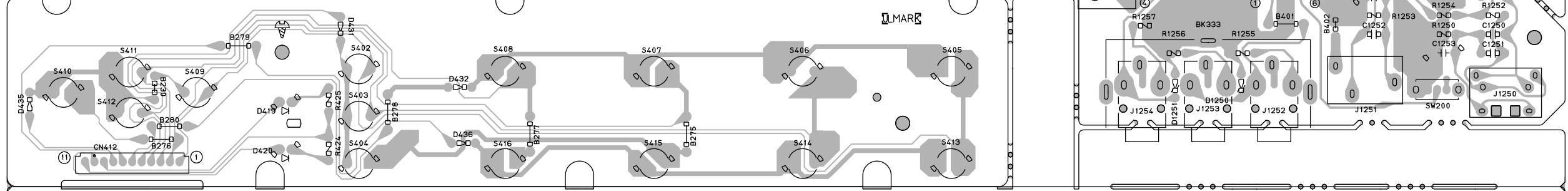

2

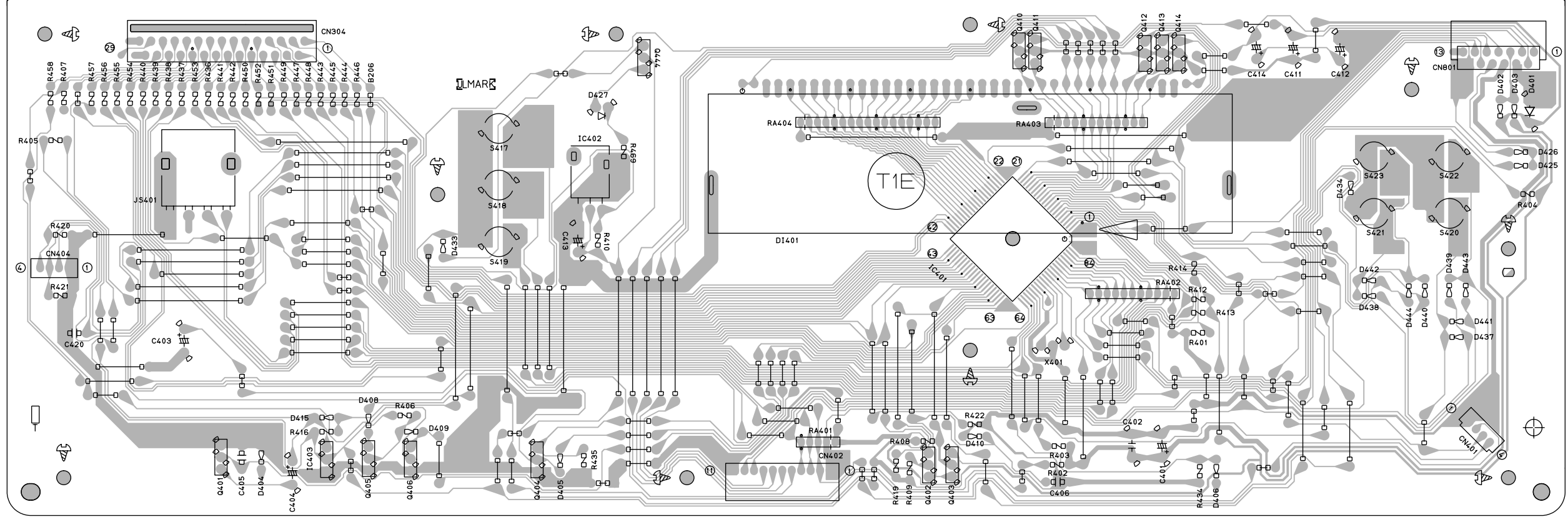

1

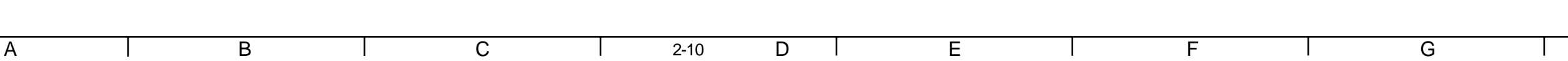

Power supply & Main board

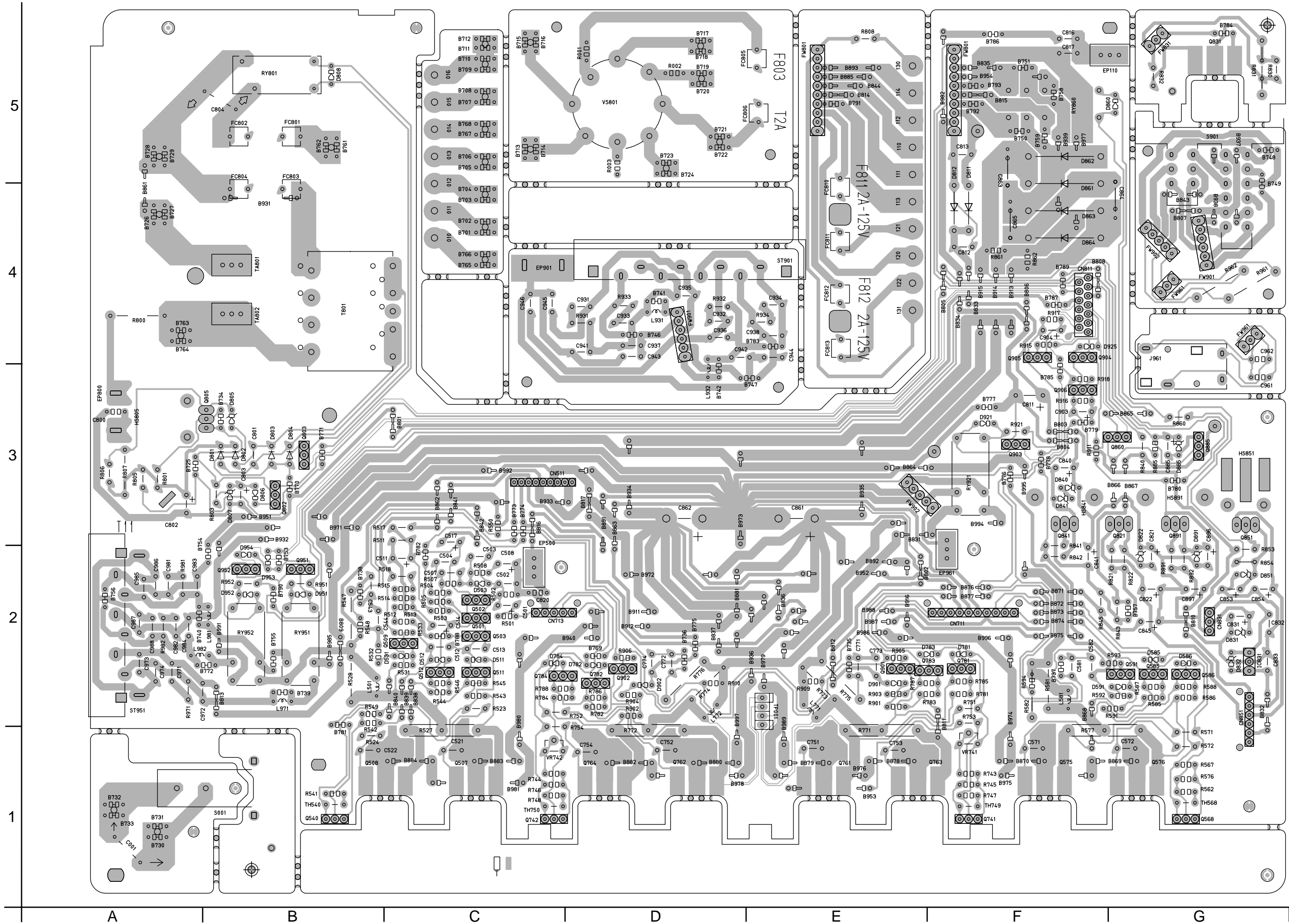

■ AV Input/output bard

5

4

3

2

1

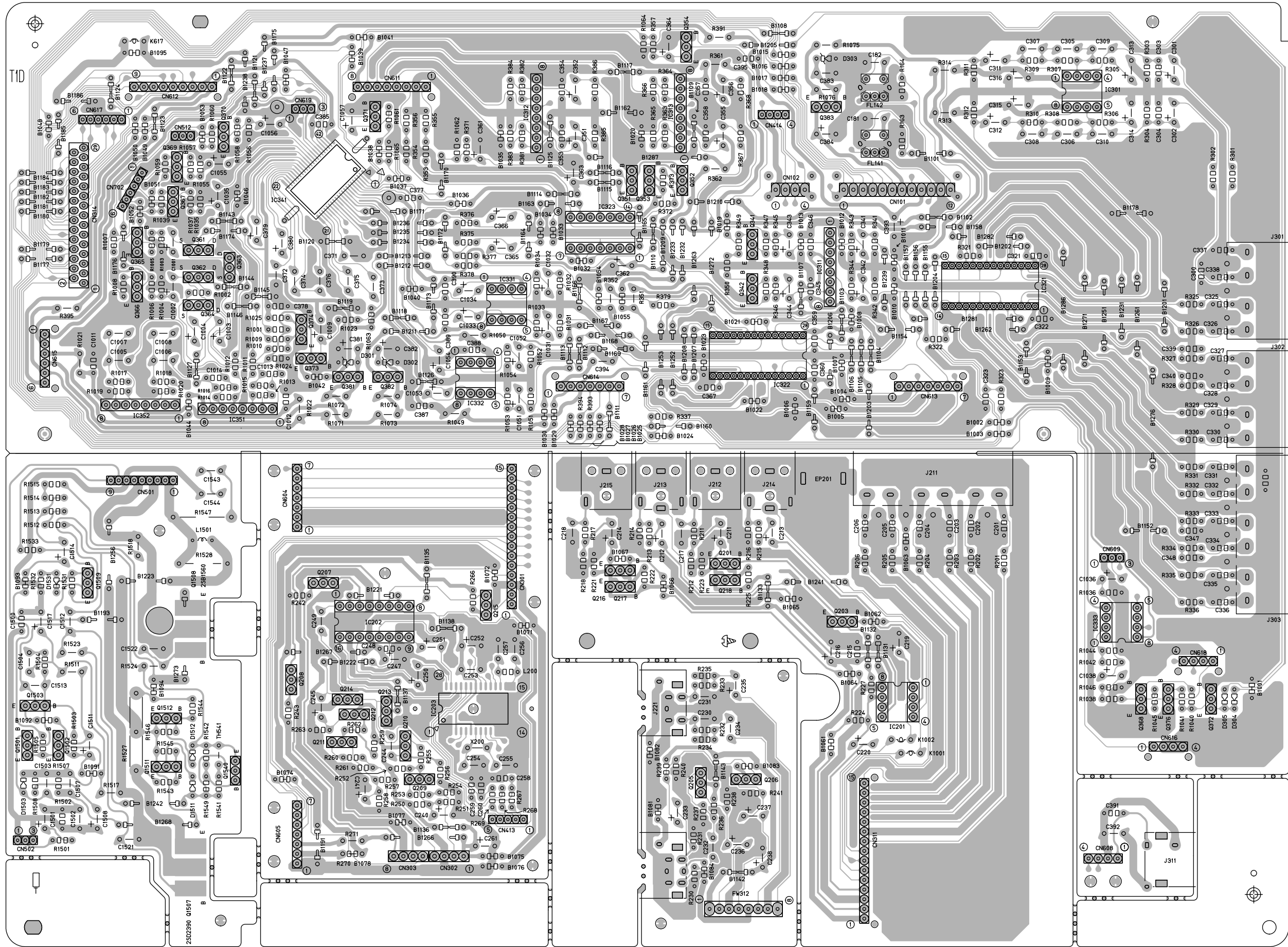

A B C 2-12 D E F G H

■ Tuner board

5
4
3
2
1

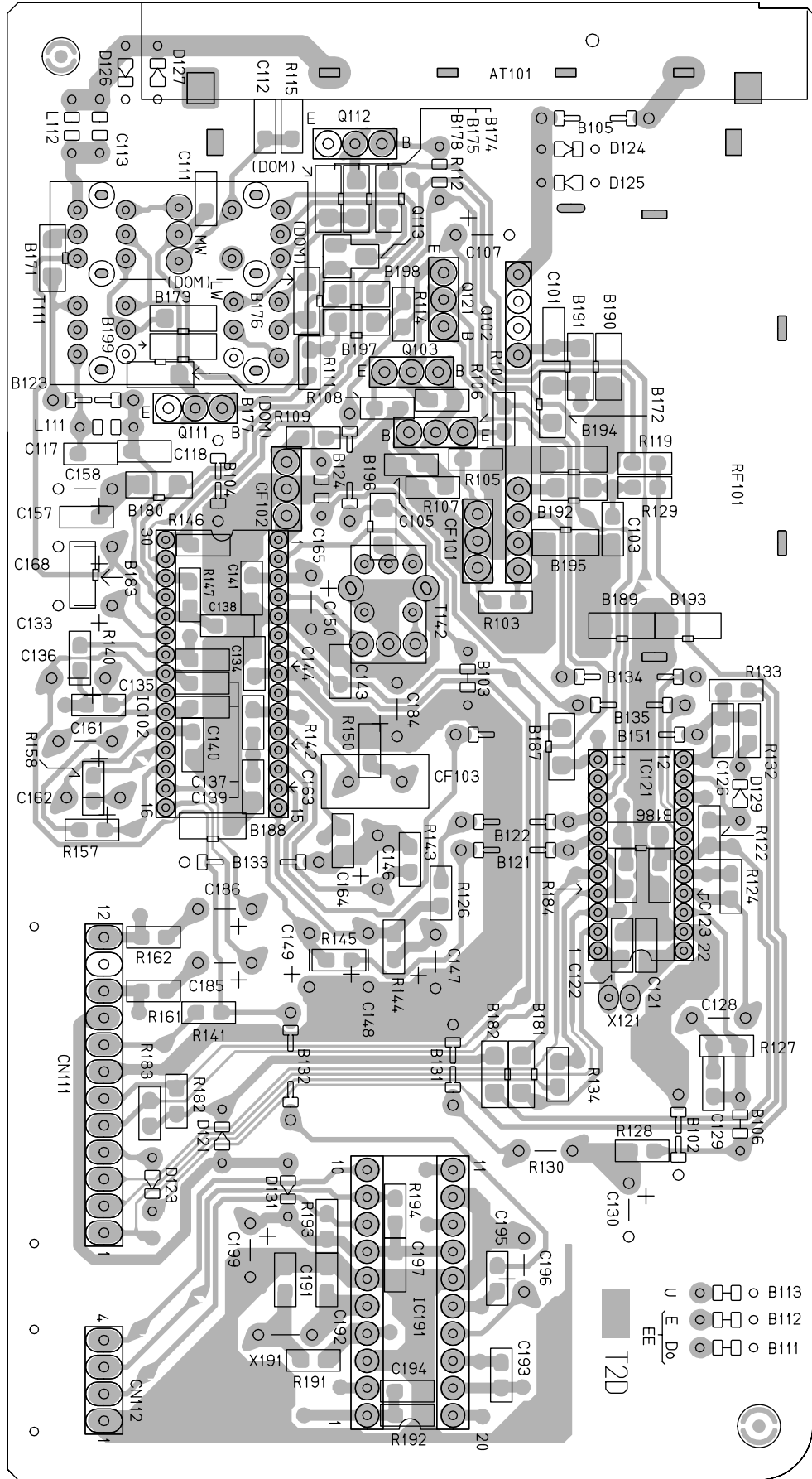

A

B

C

-MEMO-

PARTS LIST

[RX-5000VBK]
[RX-5001VGD]

* All printed circuit boards and its assemblies are not available as service parts.

RX-5000VBK
Area suffix
UF ----- China

RX-5000VGD
Area suffix
UF ----- China
US ----- Singapore

- Contents -

Exploded view of general assembly and parts list	3-3
Electrical parts list	3-6
Packing materials and accessories parts list	3-17

-MEMO-

Exploded view of general assembly and parts list

Block No. **M 1 M M**

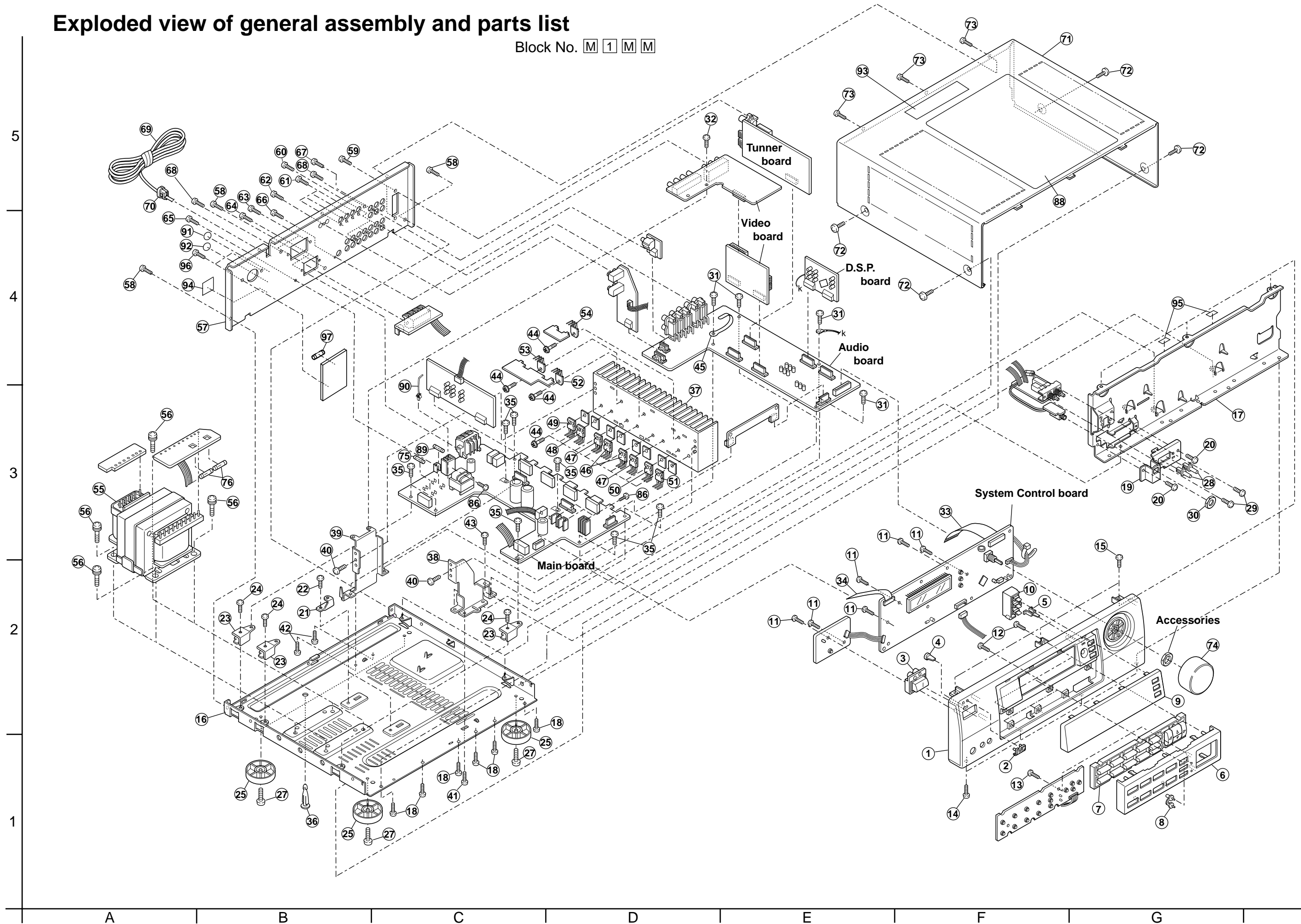

■ Parts list (General assembly)

Block No. M1MM

△	Item	Parts number	Parts name	Q'ty	Description	Area
	1	LV10128-022A	FRONT PANEL	1	RX-5001VGD	
		LV10128-020A	FRONT PANEL	1	RX-5000VBK	
	2	VJD5429-001SS	JVC MARK	1		
	3	LV30684-004A	POWER BUTTON	1	RX-5001VGD	
		LV30684-002A	POWER BUTTON	1	RX-5000VBK	
	4	FSJD4001-002	INDICATOR	1	POWER	
	5	LV40767-001A	INDICATOR	1	BASS BOOST	
	6	LV20228-008A	FRONT ESC.	1	RX-5001VGD	
		LV20228-007A	FRONT ESC.	1	RX-5000VBK	
	7	LV20227-001A	SOURCE BUTTON	1	RX-5000VBK	
		LV20227-004A	SOURCE BUTTON	1	RX-5001VGD	
	8	LV40604-001A	INDICATOR	1		
	9	LV20229-015A	LENS	1	RX-5001VGD	
		LV20229-013A	LENS	1	RX-5000VBK	
	10	LV30685-001A	PUSH BUTTON	1	SEA	
	11	QYSDSF2608Z	SCREW	6	F.C.B-F.PANEL	
	12	QYSDSF2608Z	SCREW	6	F.ESC.-F.PANEL	
	13	QYSDSF2608Z	SCREW	1	C.B-F.ESC.	
	14	QYSDSG3008M	SCREW	4	F.P-F.B(LOW)	
	15	QYSBSG3008E	T.SCREW	3	F.P-F.B(UP)	
	16	LE10081-004A	CHASSIS BASE	1		US
		LE10081-005A	CHASSIS BASE	1		UF
	17	LV20230-001A	FRONT BKT	1		
	18	QYSBSG3008E	T.SCREW	6	C.B-F.B	
	19	LV30687-001A	BRACKET	1		
	20	QYSBSG3008E	T.SCREW	2	BKT-F.B	
	21	E68587-223SM	CB BKT	2		
	22	QYSBST3006E	T.SCREW	2	C.B-BKT	
	23	LE40138-001A	BRACKET	3		
	24	QYSBSG3008E	T.SCREW	3	BKT-C.B	
	25	QZF6018-001	FOOT	4		
	27	QYSBST3010Z	T.SCREW	4	FOOT	
	28	E407321-007SM	PUSH BUTTON(SPK)	2	RX-5001VGD	
		E407321-002SM	PUSH BUTTON(SPK)	2	RX-5000VBK	
	29	QYSBST3006E	T.SCREW	2	SPK SW C.B	
	30	VKZ4150-001	SPECIAL NUT	1		
	31	QYSBSG3008E	T.SCREW	4	PRI.C.B-FRAME	
	32	QYSBSG3008E	T.SCREW	1		
	33	QUQ412-2918CJ	FFC WIRE	1	FW304	UF
		QUQC12-2918CJ	FFC WIRE	1	FW304	US
	34	QUQC12-1316CJ	FFC WIRE	1	FW811	US
		QUQ412-1316CJ	FFC WIRE	1	FW811	UF
	35	QYSBSG3008E	T.SCREW	8		
	36	LV30384-001A	FASTENER	1		UF
	37	LV30351-202A	HEAT SINK	1		
	38	E310171-001SM	H.S BKT	1	FRONT SIDE	
	39	E310172-001SM	H.S BKT	1	REAR SIDE	
	40	QYSBSG3008E	T.SCREW	2	H.S BKT-H.S	

■ Parts list (General assembly)

Block No. M1MM

△	Item	Parts number	Parts name	Q'ty	Description	Area
	41	QYSDSG3008M	SCREW	1	H.BKT(F)-C.BASE	
	42	QYSDSG3008M	SCREW	2	H.BKT(R)-C.BASE	
	43	QYSBSG3008E	T.SCREW	1	H.BKT(F)-F.BKT	
	44	E73525-003	SCREW	11	P.TR	
	45	VKZ4001-111S	WIRE CLAMP	1		
△	46	2SD2390LD/OPY/	TRANSISTOR	2	Q761 Q762	
△	47	2SB1560LD/OPY/	TRANSISTOR	2	Q763 Q764	
△	48	2SD2390LD/OPY/	TRANSISTOR	1	Q507	
△	49	2SB1560LD/OPY/	TRANSISTOR	1	Q508	
△	50	2SD2390LD/OPY/	TRANSISTOR	1	Q575	
△	51	2SB1560LD/OPY/	TRANSISTOR	1	Q576	
△	52	2SD2390LD/OPY/	TRANSISTOR	1	Q1507	
△	53	2SB1560LD/OPY/	TRANSISTOR	1	Q1508	
△	54	2SC4466LD/OPY/	TRANSISTOR	1	Q831	
△	55	QQT0283-001	TRANSFORMER	1		
	56	QYSDSTL4008E	SPECIAL SCREW	4	P.TRANS	
	57	LE20127-048A	REAR PANEL	1		US
		LE20127-050A	REAR PANEL	1		UF
	58	QYSBSGY3008M	SPECIAL SCREW	3	R.P-C.BASE	
	59	QYSBSGY3008M	SPECIAL SCREW	2	TUNER	
	60	QYSBSGY3008M	SPECIAL SCREW	3	INPUT	
	61	QYSBSGY3008M	SPECIAL SCREW	4	VIDEO	
	62	QYSBSGY3008M	SPECIAL SCREW	1	DCS	
	63	QYSBSGY3008M	SPECIAL SCREW	2	F.SPK	
	64	QYSBSGY3008M	SPECIAL SCREW	2	SURROUND	
	65	QYSBSGY3008M	SPECIAL SCREW	1	MAIN C.B	
	66	QYSBSGY3008M	SPECIAL SCREW	1	SUB.WOOF	
	67	QYSBSGY3008M	SPECIAL SCREW	1	DVD	
	68	QYSBSGY3008M	SPECIAL SCREW	2	BKT	
△	69	QMPR100-200-JC	POWER CORD	1		
△	70	QHS3771-108	CORD STOPPER	1		
	71	LE20131-006A/S/	METAL COVER	1	RX-5000VBK	
		LE20131-003A/S/	METAL COVER	1	RX-5001VGD	
	72	E406308-003	SPECIAL SCREW	4	RX-5000VBK	
		E406308-004	SPECIAL SCREW	4	RX-5001VGD	
	73	QYSBSGY3008M	SPECIAL SCREW	3	RX-5000VBK	
		QYSBSGY3008E	SPECIAL SCREW	3	RX-5001VGD	
	74	LV30480-006A	VOL KNOB ASS'Y	1	RX-5001VGD	
		LV30480-004A	VOL KNOB ASS'Y	1	RX-5000VBK	
△	75	QMF51E2-6R3-J1	FUSE	1	F801	US
△		QMF51E2-3R15-J1	FUSE	1	F801	UF
△	76	QMF51E2-2R0-J1	FUSE	2	F811 F812	
	86	QYSBSG3008E	T.SCREW	4		
	88	E208294-001SM	PROTECT SHEET	1	RX-5000VBK	
		E208294-002SM	PROTECT SHEET	1	RX-5001VGD	
△	89	QMF51E2-R10-J1	FUSE	1	F802	
	90	E307572-001	FASTENER	1		
	91	LV41768-001A	CCIB LABEL	1		UF

■ Parts list (General assembly)
Block No. M1MM

▲	Item	Parts number	Parts name	Q'ty	Description	Area
	92	E409372-001	CCEE LABEL	1		UF
	93	E409396-001	CAUTION LABEL	1		
	94	LV30092-091A	UF LABEL	1	RX-5001VGD	UF
		LV30092-090A	UF LABEL	1	RX-5000VBK	UF
	95	LV30225-024A	FELT SPACER	2	RX-5001VGD	
	96	QYSBSGY3008M	SPECIAL SCREW	2	VOL.SEL	US
▲	97	QMF51E2-3R15-J1	FUSE	1	F803	US

Electrical parts list

■ Electrical parts list (System control & DSP board) Block No. 01

Item	Parts number	Parts name	Remarks	Area	Item	Parts number	Parts name	Remarks	Area
C 401	QEKC1AM-227Z	E CAPACITOR	220MF 20% 10V		C 712	QETN1CM-107Z	E CAPACITOR	100MF 20% 16V	
C 402	QCZ0202-155Z	ML C CAPACITOR	1.5MF		C 713	QCS11HJ-220	C CAPACITOR	22PF 5% 50V	
C 403	QEZ0227-479Z	EDL CAPACITOR	47000MF		C 714	QCS11HJ-220	C CAPACITOR	22PF 5% 50V	
C 404	QEKC1HM-225Z	E CAPACITOR	2.2MF 20% 50V		C 717	QCB31HK-152Z	C CAPACITOR	1500PF 10% 50V	
C 405	QDVB1EZ-223Y	C CAPACITOR			C 718	QCB31HK-152Z	C CAPACITOR	1500PF 10% 50V	
C 406	QCB31HK-331Y	C CAPACITOR	330PF 10% 50V		C 721	QCS32HJ-220Z	C CAPACITOR	22PF 5% 500V	
C 411	QEKC1HM-475Z	E CAPACITOR	4.7MF 20% 50V		C 722	QCS32HJ-220Z	C CAPACITOR	22PF 5% 500V	
C 412	QEKC1HM-475Z	E CAPACITOR	4.7MF 20% 50V		C 723	QETN1HM-336Z	E CAPACITOR	33MF 20% 50V	
C 413	QEKC1AM-107Z	E CAPACITOR	100MF 20% 10V		C 724	QETN1HM-336Z	E CAPACITOR	33MF 20% 50V	
C 414	QEKC1HM-475Z	E CAPACITOR	4.7MF 20% 50V		C 727	QFN31HJ-103Z	M CAPACITOR	.010MF 5% 50V	UF
C 551	QETN1HM-106Z	E CAPACITOR	10MF 20% 50V		C 727	QFLC1HJ-103Z	M CAPACITOR	.010MF 5% 50V	US
C 552	QCS31HJ-271Z	C CAPACITOR	270PF 5% 50V		C 728	QFLC1HJ-103Z	M CAPACITOR	.010MF 5% 50V	US
C 553	QCS11HJ-101	C CAPACITOR	100PF 5% 50V		C 728	QFN31HJ-103Z	M CAPACITOR	.010MF 5% 50V	UF
C 556	QCB31HK-152Z	C CAPACITOR	1500PF 10% 50V		C 739	QETN1JM-107Z	E CAPACITOR	100MF 20% 63V	
C 557	QCS11HJ-220	C CAPACITOR	22PF 5% 50V		CN304	QGF1210G1-29	FFC/FPC CONNE		
C 558	QETN1CM-476Z	E CAPACITOR	47MF 20% 16V		CN401	QJK018-041004	SKT.WIRE ASSY		
C 561	QETN1HM-225Z	E CAPACITOR	2.2MF 20% 50V		CN402	QGA2001F1-11	11P CN RIG		
C 562	QCS32HJ-330Z	C CAPACITOR	33PF 5% 500V		CN411	QGA2001F1-04	4P PLUG ASSY		
C 563	QFLC1HJ-103Z	M CAPACITOR	.010MF 5% 50V	US	CN412	QJK018-111001	CONN.WIRE ASSY		US
C 563	QFN31HJ-103Z	M CAPACITOR	.010MF 5% 50V	UF	CN412	QJB002-111001	SKT.WIRE ASSY		UF
C 564	QETN1HM-476Z	E CAPACITOR	47MF 20% 50V		CN601	QGB2510K1-08	CONNECTOR		
C 601	QETN1HM-475Z	E CAPACITOR	4.7MF 20% 50V		CN602	QGB2510K1-09	CONNECTOR		
C 602	QETN1HM-475Z	E CAPACITOR	4.7MF 20% 50V		CN605	QGB2510K1-06	CONNECTOR		
C 603	QDXB1CM-222Y	C CAPACITOR			CN606	QGB2510K1-04	CONNECTOR		
C 604	QDXB1CM-222Y	C CAPACITOR			CN701	QGB2510K1-10	CONNECTOR		
C 605	QETN1HM-475Z	E CAPACITOR	4.7MF 20% 50V		CN703	QGB2510K1-05	CONNECTOR		
C 606	QETN1HM-475Z	E CAPACITOR	4.7MF 20% 50V		CN712	QGA2001F1-06	6P PLUG ASSY		
C 607	QDXB1CM-222Y	C CAPACITOR			CN801	QGF1205F1-13	CONNECTOR		
C 608	QDXB1CM-222Y	C CAPACITOR			CN841	QGB2510K1-06	CONNECTOR		
C 609	QETN1HM-475Z	E CAPACITOR	4.7MF 20% 50V		C1252	QCB31HK-221Y	C CAPACITOR	220PF 10% 50V	
C 610	QETN1HM-475Z	E CAPACITOR	4.7MF 20% 50V		C1254	QFVJ1HJ-104Z	MF CAPACITOR	.10MF 5% 50V	
C 611	QDXB1CM-222Y	C CAPACITOR			D 401	1SR139-400-T4	DIODE		
C 612	QDXB1CM-222Y	C CAPACITOR			D 402	1SS133-T2	SI DIODE		
C 613	QETN1CM-476Z	E CAPACITOR	47MF 20% 16V		D 403	1SS133-T2	SI DIODE		
C 614	QETN1CM-476Z	E CAPACITOR	47MF 20% 16V		D 404	1SS133-T2	SI DIODE		
C 615	QETN1CM-476Z	E CAPACITOR	47MF 20% 16V		D 410	1SS133-T2	SI DIODE		
C 616	QETN1CM-476Z	E CAPACITOR	47MF 20% 16V		D 411	SLR-342VC-T	LED	(STAND-BY)	
C 617	QETN1CM-476Z	E CAPACITOR	47MF 20% 16V		D 415	1SS133-T2	SI DIODE		
C 618	QETN1CM-476Z	E CAPACITOR	47MF 20% 16V		D 419	SLR-342VC-T	LED	ONE TOUCH	
C 619	QETN1CM-476Z	E CAPACITOR	47MF 20% 16V		D 420	SLR-342VC-T	LED	INPUT ATT	
C 620	QETN1CM-476Z	E CAPACITOR	47MF 20% 16V		D 425	1SS133-T2	SI DIODE		
C 621	QETN1CM-476Z	E CAPACITOR	47MF 20% 16V		D 426	1SS133-T2	SI DIODE		
C 622	QDYB1CM-103Y	C CAPACITOR			D 427	SLR-342VC-T	LED		
C 623	QETN1CM-476Z	E CAPACITOR	47MF 20% 16V		D 431	1SS133-T2	SI DIODE		
C 624	QDYB1CM-103Y	C CAPACITOR			D 432	1SS133-T2	SI DIODE		
C 628	QETN0JM-108Z	E CAPACITOR	1000MF 20% 6.3V		D 433	1SS133-T2	SI DIODE		
C 630	QCZ0202-155Z	ML C CAPACITOR	1.5MF		D 435	1SS133-T2	SI DIODE		
C 631	QDYB1CM-103Y	C CAPACITOR			D 436	1SS133-T2	SI DIODE		
C 632	QETN0JM-108Z	E CAP.(C633)	1000MF 20% 6.3V		D 439	1SS133-T2	SI DIODE	(BAND2)	
C 633	QCZ0202-155Z	ML C CAPA.(C632)	(C632)		D 553	1SS133-T2	SI DIODE		
C 634	QDYB1CM-103Y	C CAPACITOR			D 703	1SS133-T2	SI DIODE		
C 635	QDGB1HK-102Y	C CAPACITOR			D 704	1SS133-T2	SI DIODE		
C 636	QCS11HJ-100	C CAPACITOR	10PF 5% 50V		D 711	SLR-342MC-T	LED		
C 637	QCS11HJ-470	C CAPACITOR	47PF 5% 50V		D 712	SLR-342MC-T	LED		
C 638	QCB31HK-182Z	C CAPACITOR	1800PF 10% 50V		DI401	QLF0002-001	FL		
C 639	QCZ0202-155Z	ML C CAPACITOR	1.5MF		FH001	E309106-001SM	FL HOLDER		
C 701	QETN1HM-106Z	E CAPACITOR	10MF 20% 50V		FS001	E3400-444	FELT SPACER		
C 702	QETN1HM-106Z	E CAPACITOR	10MF 20% 50V		FS002	E3400-444	FELT SPACER		
C 703	QCS31HJ-271Z	C CAPACITOR	270PF 5% 50V		HL401	VYH7653-001	IC HOLDER		
C 704	QCS31HJ-271Z	C CAPACITOR	270PF 5% 50V		HL601	VYH7237-002SC	IC HOLDER		
C 705	QCS11HJ-101	C CAPACITOR	100PF 5% 50V		IC401	MN173222BA	IC		
C 706	QCS11HJ-101	C CAPACITOR	100PF 5% 50V		IC402	GP1U281X	IC		
C 711	QETN1CM-107Z	E CAPACITOR	100MF 20% 16V		IC403	IC-PST9139-T	IC		

■ Electrical parts list (System control & DSP board) Block No. 01

△	Item	Parts number	Parts name	Remarks	Area	△	Item	Parts number	Parts name	Remarks	Area
	IC601	TC9471F	IC				R 454	QRE141J-152Y	C RESISTOR	1.5K 5% 1/4W	
	JS401	QSW0502-001	SWITCH				R 455	QRE141J-221Y	C RESISTOR	220 5% 1/4W	
	J1251	QNS0083-001	3.5 JACK				R 456	QRE141J-221Y	C RESISTOR	220 5% 1/4W	
	L 601	QQL231K-2R2Y	INDUCTOR				R 457	QRE141J-221Y	C RESISTOR	220 5% 1/4W	
	Q 401	KRC107M-T	D.TRANSISTOR				R 458	QRE141J-221Y	C RESISTOR	220 5% 1/4W	
	Q 402	KRC111M-T	TRANSISTOR				R 469	QRE141J-221Y	C RESISTOR	220 5% 1/4W	
	Q 403	KRC109M-T	D.TRANSISTOR				R 551	QRE141J-222Y	C RESISTOR	2.2K 5% 1/4W	
	Q 410	KRC107M-T	D.TRANSISTOR				R 552	QRE141J-563Y	C RESISTOR	56K 5% 1/4W	
	Q 411	KRC107M-T	D.TRANSISTOR				R 553	QRE141J-302Y	C RESISTOR	3.0K 5% 1/4W	
	Q 412	KRC107M-T	D.TRANSISTOR				R 555	QRE141J-183Y	C RESISTOR	18K 5% 1/4W	
	Q 413	KRC107M-T	D.TRANSISTOR				R 556	QRE141J-101Y	C RESISTOR	100 5% 1/4W	
	Q 414	KRC107M-T	D.TRANSISTOR				R 558	QRE141J-301Y	C RESISTOR	300 5% 1/4W	
	Q 444	KRC107M-T	D.TRANSISTOR				R 560	QRE141J-563Y	C RESISTOR	56K 5% 1/4W	
	Q 551	2SC2240/L-T	TRANSISTOR			△	R 561	QRJ146J-331X	UNF C.RESISTOR	330 5% 1/4W	
	Q 552	2SC2240/L-T	TRANSISTOR				R 563	QRE141J-332Y	C RESISTOR	3.3K 5% 1/4W	
	Q 561	2SA1038S/SE-T	TRANSISTOR				R 564	QRE141J-332Y	C RESISTOR	3.3K 5% 1/4W	
	Q 701	2SC2240/L-T	TRANSISTOR				R 565	QRE141J-332Y	C RESISTOR	3.3K 5% 1/4W	
	Q 702	2SC2240/L-T	TRANSISTOR				R 566	QRE141J-332Y	C RESISTOR	3.3K 5% 1/4W	
	Q 703	2SC2240/L-T	TRANSISTOR			△	R 569	QRJ146J-100X	UNF.C RESISTOR	10 5% 1/4W	
	Q 704	2SC2240/L-T	TRANSISTOR			△	R 570	QRJ146J-100X	UNF.C RESISTOR	10 5% 1/4W	
	Q 707	2SA1038S/SE-T	TRANSISTOR				R 601	QRE141J-271Y	C RESISTOR	270 5% 1/4W	
	Q 708	2SA1038S/SE-T	TRANSISTOR				R 602	QRE141J-271Y	C RESISTOR	270 5% 1/4W	
	Q 711	2SC2389S/SE-T	TRANSISTOR				R 603	QRE141J-271Y	C RESISTOR	270 5% 1/4W	
	Q 712	2SC2389S/SE-T	TRANSISTOR				R 604	QRE141J-271Y	C RESISTOR	270 5% 1/4W	
	R 401	QRE141J-103Y	C RESISTOR	10K 5% 1/4W			R 605	QRE141J-271Y	C RESISTOR	270 5% 1/4W	
	R 402	QRE141J-331Y	C RESISTOR	330 5% 1/4W			R 606	QRE141J-271Y	C RESISTOR	270 5% 1/4W	
	R 403	QRE141J-223Y	C RESISTOR	22K 5% 1/4W			R 607	QRE141J-225Y	C RESISTOR	2.2M 5% 1/4W	
	R 404	QRE141J-103Y	C RESISTOR	10K 5% 1/4W			R 608	QRE141J-104Y	C RESISTOR	100K 5% 1/4W	
	R 405	QRE141J-472Y	C RESISTOR	4.7K 5% 1/4W			R 609	QRE141J-104Y	C RESISTOR	100K 5% 1/4W	
	R 408	QRE141J-103Y	C RESISTOR	10K 5% 1/4W			R 610	QRE141J-104Y	C RESISTOR	100K 5% 1/4W	
	R 409	QRE141J-471Y	C RESISTOR	470 5% 1/4W			R 611	QRE141J-104Y	C RESISTOR	100K 5% 1/4W	
	R 410	QRE141J-103Y	C RESISTOR	10K 5% 1/4W			R 612	QRE141J-103Y	C RESISTOR	10K 5% 1/4W	
	R 411	QRE141J-221Y	C RESISTOR	220 5% 1/4W			R 613	QRE141J-103Y	C RESISTOR	10K 5% 1/4W	
	R 412	QRE141J-103Y	C RESISTOR	10K 5% 1/4W			R 614	QRE141J-103Y	C RESISTOR	10K 5% 1/4W	
	R 413	QRE141J-103Y	C RESISTOR	10K 5% 1/4W			R 701	QRE141J-222Y	C RESISTOR	2.2K 5% 1/4W	
	R 414	QRE141J-103Y	C RESISTOR	10K 5% 1/4W			R 702	QRE141J-222Y	C RESISTOR	2.2K 5% 1/4W	
	R 416	QRE141J-103Y	C RESISTOR	10K 5% 1/4W			R 703	QRE141J-683Y	C RESISTOR	68K 5% 1/4W	
	R 419	QRE141J-472Y	C RESISTOR	4.7K 5% 1/4W			R 704	QRE141J-683Y	C RESISTOR	68K 5% 1/4W	
	R 420	QRE141J-104Y	C RESISTOR	100K 5% 1/4W			R 705	QRE141J-202Y	C RESISTOR	2.0K 5% 1/4W	
	R 421	QRE141J-104Y	C RESISTOR	100K 5% 1/4W			R 706	QRE141J-202Y	C RESISTOR	2.0K 5% 1/4W	
	R 422	QRE141J-104Y	C RESISTOR	100K 5% 1/4W			R 709	QRE141J-223Y	C RESISTOR	22K 5% 1/4W	
	R 424	QRE141J-221Y	C RESISTOR	220 5% 1/4W			R 710	QRE141J-223Y	C RESISTOR	22K 5% 1/4W	
	R 425	QRE141J-221Y	C RESISTOR	220 5% 1/4W			R 711	QRE141J-391Y	C RESISTOR	390 5% 1/4W	
	R 434	QRE141J-103Y	C RESISTOR	10K 5% 1/4W			R 712	QRE141J-391Y	C RESISTOR	390 5% 1/4W	
	R 435	QRE141J-103Y	C RESISTOR	10K 5% 1/4W			R 713	QRE141J-563Y	C RESISTOR	56K 5% 1/4W	
	R 436	QRE141J-221Y	C RESISTOR	220 5% 1/4W			R 714	QRE141J-563Y	C RESISTOR	56K 5% 1/4W	
	R 437	QRE141J-221Y	C RESISTOR	220 5% 1/4W			R 717	QRE141J-101Y	C RESISTOR	100 5% 1/4W	
	R 438	QRE141J-221Y	C RESISTOR	220 5% 1/4W			R 718	QRE141J-101Y	C RESISTOR	100 5% 1/4W	
	R 439	QRE141J-221Y	C RESISTOR	220 5% 1/4W		△	R 721	QRJ146J-121X	UNF C.RESISTOR	120 5% 1/4W	
	R 440	QRE141J-221Y	C RESISTOR	220 5% 1/4W		△	R 722	QRJ146J-121X	UNF C.RESISTOR	120 5% 1/4W	
	R 441	QRE141J-221Y	C RESISTOR	220 5% 1/4W			R 727	QRE141J-473Y	C RESISTOR	47K 5% 1/4W	
	R 442	QRE141J-221Y	C RESISTOR	220 5% 1/4W			R 728	QRE141J-473Y	C RESISTOR	47K 5% 1/4W	
	R 443	QRE141J-221Y	C RESISTOR	220 5% 1/4W		△	R 729	QRJ146J-471X	UNF C.RESISTOR	470 5% 1/4W	
	R 444	QRE141J-221Y	C RESISTOR	220 5% 1/4W		△	R 730	QRJ146J-471X	UNF C.RESISTOR	470 5% 1/4W	
	R 445	QRE141J-221Y	C RESISTOR	220 5% 1/4W		△	R 739	QRJ146J-100X	UNF.C RESISTOR	10 5% 1/4W	
	R 446	QRE141J-221Y	C RESISTOR	220 5% 1/4W		△	R 740	QRJ146J-100X	UNF.C RESISTOR	10 5% 1/4W	
	R 447	QRE141J-221Y	C RESISTOR	220 5% 1/4W			RA401	QRB049J-103	R.NETWORK	10K 5% 1/4W	
	R 448	QRE141J-221Y	C RESISTOR	220 5% 1/4W			RA402	QRB109J-103	R.NETWORK	10K 5% 1/0W	
	R 449	QRE141J-221Y	C RESISTOR	220 5% 1/4W			R1253	QRE141J-471Y	C RESISTOR	470 5% 1/4W	
	R 450	QRE141J-221Y	C RESISTOR	220 5% 1/4W			R1254	QRE141J-221Y	C RESISTOR	220 5% 1/4W	
	R 451	QRE141J-221Y	C RESISTOR	220 5% 1/4W			S 401	QSW0683-001Z	PUSH SWITCH	POWER	
	R 452	QRE141J-221Y	C RESISTOR	220 5% 1/4W			S 402	QSW0683-001Z	PUSH SWITCH	SURROUND	
	R 453	QRE141J-221Y	C RESISTOR	220 5% 1/4W			S 403	QSW0683-001Z	PUSH SWITCH	ONE TOUCH	

■ Electrical parts list (System control & DSP board) Block No. 01

△	Item	Parts number	Parts name	Remarks	Area
	S 404	QSW0683-001Z	PUSH SWITCH	INPUT ATT	
	S 405	QSW0683-001Z	PUSH SWITCH	DVD	
	S 406	QSW0683-001Z	PUSH SWITCH	DVD MULTI	
	S 407	QSW0683-001Z	PUSH SWITCH	VCR	
	S 408	QSW0683-001Z	PUSH SWITCH	FM	
	S 409	QSW0683-001Z	PUSH SWITCH	CONTROL	
	S 410	QSW0683-001Z	PUSH SWITCH	CONTROL	
	S 411	QSW0683-001Z	PUSH SWITCH	CONTROL	
	S 412	QSW0683-001Z	PUSH SWITCH	CONTROL	
	S 413	QSW0683-001Z	PUSH SWITCH	CD	
	S 414	QSW0683-001Z	PUSH SWITCH	PHONO	
	S 415	QSW0683-001Z	PUSH SWITCH	TAPE/MD	
	S 416	QSW0683-001Z	PUSH SWITCH	AM	
	S 417	QSW0683-001Z	PUSH SWITCH	ADJUT	
	S 418	QSW0683-001Z	PUSH SWITCH	SETTING	
	S 419	QSW0683-001Z	PUSH SWITCH	MEMORY	
	X 401	QAX0112-001Z	RESONATOR		
	X 601	QAX0257-001Z	RESONATOR		

■ Electrical parts list (Power supply & Main board) Block No. 02

△	Item	Parts number	Parts name	Remarks	Area	△	Item	Parts number	Parts name	Remarks	Area
	C 501	QETN1HM-106Z	E CAPACITOR	10MF 20% 50V			C 897	QETN1EM-107Z	E CAPACITOR	100MF 20% 25V	
	C 502	QCS31HJ-271Z	C CAPACITOR	270PF 5% 50V			C 903	QETN1CM-476Z	E CAPACITOR	47MF 20% 16V	
	C 503	QCS11HJ-101	C CAPACITOR	100PF 5% 50V			C 904	QETN1EM-106Z	E CAPACITOR	10MF 20% 25V	
	C 504	QCB31HK-152Z	C CAPACITOR	1500PF 10% 50V			C 941	QCS11HJ-221	C CAPACITOR	220PF 5% 50V	
	C 507	QCS11HJ-220	C CAPACITOR	22PF 5% 50V			C 942	QCS11HJ-221	C CAPACITOR	220PF 5% 50V	
	C 508	QETN1CM-476Z	E CAPACITOR	47MF 20% 16V			C 943	QCS11HJ-221	C CAPACITOR	220PF 5% 50V	
	C 511	QETN1HM-225Z	E CAPACITOR	2.2MF 20% 50V			C 944	QCS11HJ-221	C CAPACITOR	220PF 5% 50V	
	C 512	QFN31HJ-103Z	M CAPACITOR	.010MF 5% 50V	UF		C 945	QCS11HJ-221	C CAPACITOR	220PF 5% 50V	
	C 512	QFLC1HJ-103Z	M CAPACITOR	.010MF 5% 50V	US		C 946	QCS11HJ-221	C CAPACITOR	220PF 5% 50V	
	C 513	QCS32HJ-330Z	C CAPACITOR	33PF 5% 500V			C 961	QCB1HK-331Y	C CAPACITOR	330PF 10% 50V	
	C 514	QETN1HM-476Z	E CAPACITOR	47MF 20% 50V			C 962	QCB1HK-331Y	C CAPACITOR	330PF 10% 50V	
	C 517	QETC2AM-106Z	E.CAPACITOR	10MF 20% 100V	UF		C 972	QCS11HJ-221	C CAPACITOR	220PF 5% 50V	
	C 517	QETN2AM-106Z	AL E .CAPACITOR	10MF 20% 100V	US		C 983	QCS11HJ-221	C CAPACITOR	220PF 5% 50V	
	C 521	QCS32HJ-470Z	C CAPACITOR	47PF 5% 500V			C 984	QCS11HJ-221	C CAPACITOR	220PF 5% 50V	
	C 522	QCS32HJ-470Z	C CAPACITOR	47PF 5% 500V			CN511	QGA2001C1-09	9P PLUG ASSY		
	C 543	QFN31HJ-473Z	M CAPACITOR	.047MF 5% 50V	UF		CN711	QGB2510J1-10	CONNECTOR		
	C 543	QFLC1HJ-473Z	M CAPACITOR	.047MF 5% 50V	US		CN713	QGB2510J1-05	CONNECTOR		
	C 544	QFLC1HJ-223Z	M CAPACITOR	.022MF 5% 50V	US		CN811	QGF1205C1-13	CONNECTOR		
	C 544	QFN31HJ-223Z	M CAPACITOR	.022MF 5% 50V	UF		CN831	QGD2501C1-03Z	SOCKET		
	C 571	QCS32HJ-470Z	C CAPACITOR	47PF 5% 500V			CN851	QGB2510J1-06	CONNECTOR		
	C 572	QCS32HJ-470Z	C CAPACITOR	47PF 5% 500V			D 503	1SS133-T2	SI DIODE		
	C 581	QFN31HJ-473Z	M CAPACITOR	.047MF 5% 50V	UF		D 511	1SS133-T2	SI DIODE		
	C 581	QFLC1HJ-473Z	M CAPACITOR	.047MF 5% 50V	US		D 512	1SS133-T2	SI DIODE		
	C 582	QFLC1HJ-223Z	M CAPACITOR	.022MF 5% 50V	US		D 531	1SS133-T2	SI DIODE		
	C 582	QFN31HJ-223Z	M CAPACITOR	.022MF 5% 50V	UF		D 585	1SS133-T2	SI DIODE		
	C 751	QCS32HJ-470Z	C CAPACITOR	47PF 5% 500V			D 586	1SS133-T2	SI DIODE		
	C 752	QCS32HJ-470Z	C CAPACITOR	47PF 5% 500V			D 591	1SS133-T2	SI DIODE		
	C 753	QCS32HJ-470Z	C CAPACITOR	47PF 5% 500V			D 781	1SS133-T2	SI DIODE		
	C 754	QCS32HJ-470Z	C CAPACITOR	47PF 5% 500V			D 782	1SS133-T2	SI DIODE		
	C 771	QFN31HJ-473Z	M CAPACITOR	.047MF 5% 50V	UF		D 783	1SS133-T2	SI DIODE		
	C 771	QFLC1HJ-473Z	M CAPACITOR	.047MF 5% 50V	US		D 784	1SS133-T2	SI DIODE		
	C 772	QFLC1HJ-473Z	M CAPACITOR	.047MF 5% 50V	US		△ D 801	1SR35-400A-T5	DIODE		
	C 772	QFN31HJ-473Z	M CAPACITOR	.047MF 5% 50V	UF		△ D 802	1SR35-400A-T5	DIODE		
	C 773	QFN31HJ-223Z	M CAPACITOR	.022MF 5% 50V	UF		△ D 803	1SR35-400A-T5	DIODE		
	C 773	QFLC1HJ-223Z	M CAPACITOR	.022MF 5% 50V	US		△ D 804	1SR35-400A-T5	DIODE		
	C 774	QFLC1HJ-223Z	M CAPACITOR	.022MF 5% 50V	US		D 805	MTZJ12C-T2	ZENER DIODE		
	C 774	QFN31HJ-223Z	M CAPACITOR	.022MF 5% 50V	UF		D 806	1SS133-T2	SI DIODE		
	C 801	QFN32AK-472Z	M.CAPACITOR	4700PF 10% 100V			D 807	MTZJ6.8C-T2	Z DIODE		
	C 802	QETM1JM-477	E CAPACITOR	470MF 20% 63V			D 808	1SS133-T2	SI DIODE		
	C 803	QETN1AM-477Z	E CAPACITOR	470MF 20% 10V			△ D 811	10E2-FD	DIODE		
△	C 804	QCZ9019-472	C.CAPACITOR	4700PF			△ D 812	10E2-FD	DIODE		
	C 811	QETM1VM-228	E CAPACITOR	2200MF 20% 35V			D 822	MTZJ13C-T2	ZENER DIODE		
	C 812	QFN32AJ-104Z	M CAPACITER	.10MF 5% 100V			D 831	MTZJ7.5C-T2	ZENER DIODE		
	C 813	QFN32AJ-104Z	M.CAPACITOR	.10MF 5% 100V			D 832	MTZJ3.3B-T2	ZENER DIODE		
	C 816	QCF31HZ-223Z	C CAPACITOR	.022MF +80:-20%			D 840	MTZJ10C-T2	Z.DIODE		
	C 817	QCF31HZ-223Z	C CAPACITOR	.022MF +80:-20%			D 841	MTZJ16C-T2	Z.DIODE		
	C 821	QETN1HM-476Z	E CAPACITOR	47MF 20% 50V			D 851	MTZJ13C-T2	ZENER DIODE		
	C 822	QETN1HM-476Z	E CAPACITOR	47MF 20% 50V			D 860	1SS133-T2	SI DIODE		
	C 831	QETN1EM-107Z	E CAPACITOR	100MF 20% 25V			△ D 861	30DF2-FC	DIODE		
	C 832	QFVJ1HJ-334Z	M.CAPACITOR	.33MF 5% 50V			△ D 862	30DF2-FC	DIODE		
	C 833	QFVF1HJ-104Z	MF CAPACITOR	.10MF 5% 50V			△ D 863	30DF2-FC	DIODE		
	C 840	QETN1HM-476Z	E CAPACITOR	47MF 20% 50V			△ D 864	30DF2-FC	DIODE		
	C 841	QETN1HM-476Z	E CAPACITOR	47MF 20% 50V			D 885	MTZJ6.2C-T2	Z DIODE		
	C 845	QETN1HM-476Z	E CAPACITOR	47MF 20% 50V			D 891	MTZJ6.2C-T2	Z DIODE		
	C 853	QETN1EM-107Z	E CAPACITOR	100MF 20% 25V			D 901	1SS133-T2	SI DIODE		
	C 854	QETN1EM-107Z	E CAPACITOR	100MF 20% 25V			D 902	1SS133-T2	SI DIODE		
	C 861	QE20341-688	E CAPACITER	6800MF			D 921	1SS133-T2	SI DIODE		
	C 862	QE20341-688	E CAPACITER	6800MF			D 925	1SS133-T2	SI DIODE		
	C 863	QFN82CK-104	M CAPACITER	.10MF 10% 160V			D 951	1SS133-T2	SI DIODE		
	C 864	QFN82CK-104	M CAPACITER	.10MF 10% 160V			D 952	1SS133-T2	SI DIODE		
	C 865	QFN82CK-104	M CAPACITER	.10MF 10% 160V			EP110	QNZ0136-001Z	EARTH PLATE		
	C 885	QETN1HM-105Z	E CAPACITOR	1.0MF 20% 50V			EP500	QNZ0136-001Z	EARTH PLATE		
	C 896	QETN1EM-107Z	E CAPACITOR	100MF 20% 25V			EP800	E409182-001SM	GRAND TERMINAL		

■ Electrical parts list (Power supply & Main board) Block No. 02

△	Item	Parts number	Parts name	Remarks	Area	△	Item	Parts number	Parts name	Remarks	Area
	EP901	E409182-001SM	GRAND TERMINAL				Q 905	2SC2389S/SE/-T	TRANSISTOR		
	EP961	QNZ0136-001Z	EARTH PLATE				Q 906	2SA1038S/SE/-T	TRANSISTOR		
	FC801	QNG0020-001Z	FUSE CLIP				Q 951	KRC105M-T	D.TRANSISTOR		
	FC802	QNG0020-001Z	FUSE CLIP				Q 952	KRC105M-T	D.TRANSISTOR		
	FC803	QNG0020-001Z	FUSE CLIP				R 1	QRE141J-103Y	C RESISTOR	10K 5% 1/4W	US
	FC804	QNG0020-001Z	FUSE CLIP				R 2	QRE141J-103Y	C RESISTOR	10K 5% 1/4W	US
	FC805	QNG0020-001Z	FUSE CLIP		US		R 3	QRE141J-103Y	C RESISTOR	10K 5% 1/4W	US
	FC806	QNG0020-001Z	FUSE CLIP		US		R 501	QRE141J-222Y	C RESISTOR	2.2K 5% 1/4W	
	FC810	QNG0020-001Z	FUSE CLIP				R 502	QRE141J-563Y	C RESISTOR	56K 5% 1/4W	
	FC811	QNG0020-001Z	FUSE CLIP				R 503	QRE141J-302Y	C RESISTOR	3.0K 5% 1/4W	
	FC812	QNG0020-001Z	FUSE CLIP				R 504	QRE141J-101Y	C RESISTOR	100 5% 1/4W	
	FC813	QNG0020-001Z	FUSE CLIP				R 505	QRE141J-183Y	C RESISTOR	18K 5% 1/4W	
	FW801	QUM13A-13Z4Z4	PARA RIBON WIRE		UF		R 507	QRE141J-563Y	C RESISTOR	56K 5% 1/4W	
	FW801	QUM13A-08Z4Z4	FLAT WIRE		US		R 508	QRE141J-391Y	C RESISTOR	390 5% 1/4W	
	FW831	QUM133-10DGZ4	PARA RIBON WIRE			△	R 511	QRJ146J-331X	UNF.C.RESISTOR	330 5% 1/4W	
	FW901	QUM136-40Z4Z4	PARA RIBON WIRE				R 512	QRE141J-332Y	C RESISTOR	3.3K 5% 1/4W	
	FW902	QUM135-20Z4Z4	PARA RIBON WIRE				R 513	QRE141J-332Y	C RESISTOR	3.3K 5% 1/4W	
	FW961	QUM133-10Z4Z4	PARA RIBON WIRE				R 514	QRE141J-332Y	C RESISTOR	3.3K 5% 1/4W	
	HS805	E70945-H40B	HEAT SINK				R 515	QRE141J-332Y	C RESISTOR	3.3K 5% 1/4W	
	HS841	E70306-001	HEAT SINK			△	R 517	QRJ146J-100X	UNF.C RESISTOR	10 5% 1/4W	
	HS851	E70945-H40B	HEAT SINK			△	R 518	QRJ146J-100X	UNF.C RESISTOR	10 5% 1/4W	
	HS891	E70306-001	HEAT SINK			△	R 523	QRJ146J-100X	UNF.C RESISTOR	10 5% 1/4W	
	IC831	NJM78M05FA	IC			△	R 524	QRJ146J-100X	UNF.C RESISTOR	10 5% 1/4W	
	J 961	QNS0023-001	JACK			△	R 527	QRZ0196-R22	EMIT.RESISTOR	1/1W	
	L 501	QQLZ005-R45	INDUCTOR				R 528	QRJ125J-330	UNF.C RESISTOR	33 5% 1/2W	
	L 581	QQLZ005-R45	INDUCTOR				R 531	QRE141J-102Y	C RESISTOR	1.0K 5% 1/4W	
	L 771	QQLZ005-R45	INDUCTOR				R 532	QRE141J-183Y	C RESISTOR	18K 5% 1/4W	
	L 772	QQLZ005-R45	INDUCTOR				R 533	QRE141J-123Y	C RESISTOR	12K 5% 1/4W	
	LA801	E67132-T3R15	T3R15 FUSE LABE		UF		R 541	QRE141J-471Y	C RESISTOR	470 5% 1/4W	
	LA801	E67132-T6R3	T6R3 FUSE LABEL		US		R 542	QRE141J-361Y	C RESISTOR	360 5% 1/4W	
	LA803	E67132-T3R15	FUSE LABEL		US		R 543	QRE141J-181Y	C RESISTOR	180 5% 1/4W	
	LA811	E67132-T2R0	T2R0 FUSE LABEL				R 544	QRE141J-181Y	C RESISTOR	180 5% 1/4W	
	LA812	E67132-T2R0	T2R0 FUSE LABEL				R 545	QRE141J-181Y	C RESISTOR	180 5% 1/4W	
	Q 501	2SC2240/L/-T	TRANSISTOR				R 546	QRE141J-181Y	C RESISTOR	180 5% 1/4W	
	Q 502	2SC2240/L/-T	TRANSISTOR			△	R 547	QRL022J-100	UNF.OMF.RES.	10 5% 1/2W	
	Q 503	2SA1038S/SE/-T	TRANSISTOR				R 548	QRE141J-104Y	C RESISTOR	100K 5% 1/4W	
	Q 509	2SA1038S/SE/-T	TRANSISTOR				R 549	QRE141J-301Y	C RESISTOR	300 5% 1/4W	
	Q 511	2SC2389S/SE/-T	TRANSISTOR				R 550	QRE141J-104Y	C RESISTOR	100K 5% 1/4W	
	Q 512	2SA1038S/SE/-T	TRANSISTOR				R 562	QRE141J-471Y	C RESISTOR	470 5% 1/4W	
	Q 540	2SD637/QR/	TRANSISTOR				R 567	QRE141J-361Y	C RESISTOR	360 5% 1/4W	
	Q 568	2SD637/QR/	TRANSISTOR			△	R 571	QRJ146J-100X	UNF.C RESISTOR	10 5% 1/4W	
	Q 585	2SC2389S/SE/-T	TRANSISTOR			△	R 572	QRJ146J-100X	UNF.C RESISTOR	10 5% 1/4W	
	Q 586	2SA1038S/SE/-T	TRANSISTOR				R 576	QRE141J-301Y	C RESISTOR	300 5% 1/4W	
	Q 591	2SA1038S/SE/-T	TRANSISTOR			△	R 577	QRZ0196-R22	EMIT.RESISTOR	1/1W	
	Q 741	2SD637/QR/	TRANSISTOR			△	R 581	QRJ125J-330	UNF.C.RESISTOR	33 5% 1/2W	
	Q 742	2SD637/QR/	TRANSISTOR			△	R 582	QRL022J-100	UNF.OMF.RES.	10 5% 1/2W	
	Q 781	2SC2389S/SE/-T	TRANSISTOR				R 585	QRE141J-181Y	C RESISTOR	180 5% 1/4W	
	Q 782	2SC2389S/SE/-T	TRANSISTOR				R 586	QRE141J-181Y	C RESISTOR	180 5% 1/4W	
	Q 783	2SA1038S/SE/-T	TRANSISTOR				R 587	QRE141J-181Y	C RESISTOR	180 5% 1/4W	
	Q 784	2SA1038S/SE/-T	TRANSISTOR				R 588	QRE141J-181Y	C RESISTOR	180 5% 1/4W	
	Q 802	2SC2235/OY/-T	TRANSISTOR				R 591	QRE141J-102Y	C RESISTOR	1.0K 5% 1/4W	
	Q 803	KRC105M-T	D.TRANSISTOR				R 592	QRE141J-183Y	C RESISTOR	18K 5% 1/4W	
	Q 805	2SD1266/Q/	TRANSISTOR				R 593	QRE141J-473Y	C RESISTOR	47K 5% 1/4W	
	Q 821	2SB1566/EF/	TRANSISTOR				R 594	QRE141J-104Y	C RESISTOR	100K 5% 1/4W	
	Q 841	2SB1566/EF/	TRANSISTOR				R 743	QRE141J-471Y	C RESISTOR	470 5% 1/4W	
	Q 851	2SD2395/EF/	TRANSISTOR				R 744	QRE141J-471Y	C RESISTOR	470 5% 1/4W	
	Q 860	KRC105M-T	D.TRANSISTOR				R 745	QRE141J-361Y	C RESISTOR	360 5% 1/4W	
	Q 885	2SC2240/GL/-T	TRANSISTOR				R 746	QRE141J-361Y	C RESISTOR	360 5% 1/4W	
	Q 891	2SD2395/EF/	TRANSISTOR				R 747	QRE141J-471Y	C RESISTOR	470 5% 1/4W	
	Q 901	2SA1038S/SE/-T	TRANSISTOR				R 748	QRE141J-471Y	C RESISTOR	470 5% 1/4W	
	Q 902	2SA1038S/SE/-T	TRANSISTOR			△	R 751	QRJ146J-100X	UNF.C RESISTOR	10 5% 1/4W	
	Q 903	KRC105M-T	D.TRANSISTOR			△	R 752	QRJ146J-100X	UNF.C RESISTOR	10 5% 1/4W	
	Q 904	KTC3199/GL/-T	TRANSISTOR			△	R 753	QRJ146J-100X	UNF.C RESISTOR	10 5% 1/4W	

■ Electrical parts list (Power supply & Main board) Block No. 02

△	Item	Parts number	Parts name	Remarks	Area
△	R 754	QRJ146J-100X	UNF.C RESISTOR	10 5% 1/4W	
△	R 771	QRZ0196-R22	EMIT.RESISTOR	1/1W	
△	R 772	QRZ0196-R22	EMIT.RESISTOR	1/1W	
△	R 773	QRJ125J-330	UNF.C.RESISTOR	33 5% 1/2W	
△	R 774	QRJ125J-330	UNF.C.RESISTOR	33 5% 1/2W	
△	R 775	QRL022J-100	UNF.OMF.RES.	10 5% 1/2W	
△	R 776	QRL022J-100	UNF.OMF.RES.	10 5% 1/2W	
	R 781	QRE141J-181Y	C RESISTOR	180 5% 1/4W	
	R 782	QRE141J-181Y	C RESISTOR	180 5% 1/4W	
	R 783	QRE141J-181Y	C RESISTOR	180 5% 1/4W	
	R 784	QRE141J-181Y	C RESISTOR	180 5% 1/4W	
	R 785	QRE141J-121Y	C RESISTOR	120 5% 1/4W	
	R 786	QRE141J-121Y	C RESISTOR	120 5% 1/4W	
	R 787	QRE141J-121Y	C RESISTOR	120 5% 1/4W	
	R 788	QRE141J-121Y	C RESISTOR	120 5% 1/4W	
△	R 801	QRJ146J-3R3X	UNF C.RESISTOR	3.3 5% 1/4W	
△	R 803	QRJ146J-821X	UNF C.RESISTOR	820 5% 1/4W	
△	R 806	QRJ146J-153X	UNF C.RESISTOR	15K 5% 1/4W	
△	R 807	QRL012J-332	UNF.OMF.RES.	3.3K 5% 1/1W	
△	R 808	QRJ146J-8R2X	UNF C.RESISTOR	8.2 5% 1/4W	
△	R 821	QRJ146J-100X	UNF.C RESISTOR	10 5% 1/4W	
△	R 822	QRJ146J-182X	UNF C.RESISTOR	1.8K 5% 1/4W	
△	R 830	QRZ9006-4R7X	F RESISTOR	4.7 1/0W	
△	R 831	QRZ9006-4R7X	F RESISTOR	4.7 1/0W	
△	R 832	QRJ146J-272X	UNF C.RESISTOR	2.7K 5% 1/4W	
△	R 840	QRJ146J-220X	UNF C.RESISTOR	22 5% 1/4W	
△	R 841	QRZ9005-100X	F.RESISTOR	10 1/0W	
△	R 842	QRJ146J-472X	UNF C.RESISTOR	4.7K 5% 1/4W	
△	R 843	QRJ146J-100X	UNF.C RESISTOR	10 5% 1/4W	
△	R 845	QRJ146J-102X	UNF C.RESISTOR	1.0K 5% 1/4W	
△	R 853	QRZ9006-4R7X	F RESISTOR	4.7 1/0W	
△	R 854	QRK126J-562X	UNF.C.RESISTOR	5.6K 5% 1/2W	
△	R 860	QRJ146J-220X	UNF C.RESISTOR	22 5% 1/4W	
	R 885	QRE141J-104Y	C RESISTOR	100K 5% 1/4W	
△	R 891	QRZ9005-100X	F.RESISTOR	10 1/0W	
△	R 892	QRJ146J-272X	UNF C.RESISTOR	2.7K 5% 1/4W	
	R 901	QRE141J-102Y	C RESISTOR	1.0K 5% 1/4W	
	R 902	QRE141J-102Y	C RESISTOR	1.0K 5% 1/4W	
	R 903	QRE141J-153Y	C RESISTOR	15K 5% 1/4W	
	R 904	QRE141J-153Y	C RESISTOR	15K 5% 1/4W	
	R 905	QRE141J-473Y	C RESISTOR	47K 5% 1/4W	
	R 906	QRE141J-473Y	C RESISTOR	47K 5% 1/4W	
	R 909	QRE141J-104Y	C RESISTOR	100K 5% 1/4W	
	R 910	QRE141J-823Y	C RESISTOR	82K 5% 1/4W	
	R 911	QRE141J-103Y	C RESISTOR	10K 5% 1/4W	
	R 915	QRE141J-103Y	C RESISTOR	10K 5% 1/4W	
	R 916	QRE141J-104Y	C RESISTOR	100K 5% 1/4W	
	R 917	QRE141J-103Y	C RESISTOR	10K 5% 1/4W	
	R 918	QRE141J-104Y	C RESISTOR	100K 5% 1/4W	
△	R 921	QRJ146J-101X	UNF C.RESISTOR	100 5% 1/4W	
△	R 951	QRJ146J-101X	UNF C.RESISTOR	100 5% 1/4W	
△	R 952	QRJ146J-101X	UNF C.RESISTOR	100 5% 1/4W	
△	R 961	QRL022J-471	UNF OMF.RES.	470 5% 1/2W	
△	R 962	QRL022J-471	UNF OMF.RES.	470 5% 1/2W	
△	RY801	QSK0055-001	RELAY		
△	RY860	QSK0082-001	RELAY		
△	RY921	QSK0109-001	RELAY		
△	RY951	QSK0109-001	RELAY		
△	RY952	QSK0109-001	RELAY		
	S 901	QSW0653-001	PUSH SWITCH		
	ST901	QNB0007-001	SPK TERMINAL		
	ST951	QNB0016-001	SPK TERMINAL		
	T 801	QQT0281-004	POWER TRANSF		

△	Item	Parts number	Parts name	Remarks	Area
	TA801	QNZ0079-001Z	TAB		
	TA802	QNZ0079-001Z	TAB I.M		
	TH540	QAD0012-202	THERMISTOR		
	TH568	QAD0012-202	THERMISTOR		
	TH749	QAD0012-202	THERMISTOR		
	TH750	QAD0012-202	THERMISTOR		
	TP001	QMV5005-004K	4P PLUG ASSY		
	VR741	QVP0004-102Z	SEMI.V.RESISTOR		
	VR742	QVP0004-102Z	SEMI.V.RESISTOR		
△	VS801	QSW0524-001	VOLTAGE SWITCH		US

■ Electrical parts list (AV input / output board)

Block No. 03

△	Item	Parts number	Parts name	Remarks	Area
	C 181	QFN31HJ-562Z	M CAPACITOR	5600PF 5% 50V	UF
	C 181	QFLC1HJ-562Z	M CAPACITOR	5600PF 5% 50V	US
	C 182	QFLC1HJ-562Z	M CAPACITOR	5600PF 5% 50V	US
	C 182	QFN31HJ-562Z	M CAPACITOR	5600PF 5% 50V	UF
	C 201	QCB1HK-331Y	C CAPACITOR	330PF 10% 50V	
	C 202	QCB1HK-331Y	C CAPACITOR	330PF 10% 50V	
	C 203	QCB1HK-331Y	C CAPACITOR	330PF 10% 50V	
	C 204	QCB1HK-331Y	C CAPACITOR	330PF 10% 50V	
	C 205	QCB1HK-331Y	C CAPACITOR	330PF 10% 50V	
	C 206	QCB1HK-331Y	C CAPACITOR	330PF 10% 50V	
	C 211	QETN0JM-108Z	E CAPACITOR	1000MF 20% 6.3V	
	C 212	QETN1HM-475Z	E CAPACITOR	4.7MF 20% 50V	
	C 213	QETN1HM-475Z	E CAPACITOR	4.7MF 20% 50V	
	C 214	QETN0JM-108Z	E CAPACITOR	1000MF 20% 6.3V	
	C 215	QDVB1EZ-223Y	C CAPACITOR		
	C 216	QETN1CM-108Z	E CAPACITOR	1000MF 20% 16V	
	C 217	QCS11HJ-470	C CAPACITOR	47PF 5% 50V	
	C 218	QCS11HJ-470	C CAPACITOR	47PF 5% 50V	
	C 219	QETN1HM-104Z	05CAPACITOR	.10MF 20% 50V	
	C 261	QETN1EM-476Z	E CAPACITOR	47MF 20% 25V	
	C 300	QDVB1EZ-223Y	C CAPACITOR		
	C 301	QETN1HM-475Z	E CAPACITOR	4.7MF 20% 50V	
	C 302	QETN1HM-475Z	E CAPACITOR	4.7MF 20% 50V	
	C 303	QCB1HK-101Y	C CAPACITOR	100PF 10% 50V	
	C 304	QCB1HK-101Y	C CAPACITOR	100PF 10% 50V	
	C 305	QFN31HJ-182Z	M CAPACITOR	1800PF 5% 50V	UF
	C 305	QFLC1HJ-182Z	M CAPACITOR	1800PF 5% 50V	US
	C 306	QFLC1HJ-182Z	M CAPACITOR	1800PF 5% 50V	US
	C 306	QFN31HJ-182Z	M CAPACITOR	1800PF 5% 50V	UF
	C 307	QFN31HJ-682Z	M CAPACITOR	6800PF 5% 50V	UF
	C 307	QFLC1HJ-682Z	M CAPACITOR	6800PF 5% 50V	US
	C 308	QFLC1HJ-682Z	M CAPACITOR	6800PF 5% 50V	US
	C 308	QFN31HJ-682Z	M CAPACITOR	6800PF 5% 50V	UF
	C 309	QCS11HJ-101	C CAPACITOR	100PF 5% 50V	
	C 310	QCS11HJ-101	C CAPACITOR	100PF 5% 50V	
	C 311	QETN1HM-475Z	E CAPACITOR	4.7MF 20% 50V	
	C 312	QETN1HM-475Z	E CAPACITOR	4.7MF 20% 50V	
	C 313	QETN1AM-107Z	E CAPACITOR	100MF 20% 10V	
	C 314	QETN1AM-107Z	E CAPACITOR	100MF 20% 10V	
	C 315	QETN1CM-476Z	E CAPACITOR	47MF 20% 16V	
	C 316	QETN1CM-476Z	E CAPACITOR	47MF 20% 16V	
	C 321	QDVB1EZ-223Y	C CAPACITOR		
	C 322	QDVB1EZ-223Y	C CAPACITOR		
	C 323	QCB1HK-221Y	C CAPACITOR	220PF 10% 50V	
	C 325	QCB1HK-331Y	C CAPACITOR	330PF 10% 50V	
	C 326	QCB1HK-331Y	C CAPACITOR	330PF 10% 50V	
	C 327	QCB1HK-331Y	C CAPACITOR	330PF 10% 50V	
	C 328	QCB1HK-331Y	C CAPACITOR	330PF 10% 50V	
	C 329	QCB1HK-331Y	C CAPACITOR	330PF 10% 50V	
	C 330	QCB1HK-331Y	C CAPACITOR	330PF 10% 50V	
	C 331	QCB1HK-331Y	C CAPACITOR	330PF 10% 50V	
	C 332	QCB1HK-331Y	C CAPACITOR	330PF 10% 50V	
	C 333	QCB1HK-331Y	C CAPACITOR	330PF 10% 50V	
	C 334	QCB1HK-331Y	C CAPACITOR	330PF 10% 50V	
	C 335	QCB1HK-331Y	C CAPACITOR	330PF 10% 50V	
	C 336	QCB1HK-331Y	C CAPACITOR	330PF 10% 50V	
	C 337	QCB1HK-331Y	C CAPACITOR	330PF 10% 50V	
	C 338	QCB1HK-331Y	C CAPACITOR	330PF 10% 50V	
	C 339	QCB1HK-221Y	C CAPACITOR	220PF 10% 50V	
	C 340	QCB1HK-221Y	C CAPACITOR	220PF 10% 50V	
	C 341	QETN1HM-475Z	E CAPACITOR	4.7MF 20% 50V	
	C 342	QETN1HM-475Z	E CAPACITOR	4.7MF 20% 50V	
	C 343	QETN1HM-475Z	E CAPACITOR	4.7MF 20% 50V	

△	Item	Parts number	Parts name	Remarks	Area
	C 344	QETN1HM-475Z	E CAPACITOR	4.7MF 20% 50V	
	C 345	QDVB1EZ-223Y	C CAPACITOR		
	C 346	QDVB1EZ-223Y	C CAPACITOR		
	C 347	QCB1HK-221Y	C CAPACITOR	220PF 10% 50V	
	C 348	QCB1HK-221Y	C CAPACITOR	220PF 10% 50V	
	C 351	QETN1HM-105Z	E CAPACITOR	1.0MF 20% 50V	
	C 352	QETN1HM-105Z	E CAPACITOR	1.0MF 20% 50V	
	C 353	QDVB1EZ-223Y	C CAPACITOR		
	C 354	QDVB1EZ-223Y	C CAPACITOR		
	C 355	QETN1HM-105Z	E CAPACITOR	1.0MF 20% 50V	
	C 356	QETN1HM-105Z	E CAPACITOR	1.0MF 20% 50V	
	C 357	QDVB1EZ-223Y	C CAPACITOR		
	C 358	QDVB1EZ-223Y	C CAPACITOR		
	C 359	QDVB1EZ-223Y	C CAPACITOR		
	C 360	QDVB1EZ-223Y	C CAPACITOR		
	C 361	QETN1HM-475Z	E CAPACITOR	4.7MF 20% 50V	
	C 362	QETN1EM-226Z	E CAPACITOR	22MF 20% 25V	
	C 363	QETN1EM-226Z	E CAPACITOR	22MF 20% 25V	
	C 364	QETN1HM-475Z	E CAPACITOR	4.7MF 20% 50V	
	C 365	QETN1HM-225Z	E CAPACITOR	2.2MF 20% 50V	
	C 366	QETN1HM-225Z	E CAPACITOR	2.2MF 20% 50V	
	C 367	QCB1HK-221Y	C CAPACITOR	220PF 10% 50V	
	C 371	QCB1HK-822Z	C CAPACITOR	8200PF 10% 50V	
	C 372	QCB1HK-822Z	C CAPACITOR	8200PF 10% 50V	
	C 373	QFN31HJ-153Z	M CAPACITOR	.015MF 5% 50V	UF
	C 373	QFLC1HJ-153Z	M CAPACITOR	.015MF 5% 50V	US
	C 374	QFLC1HJ-153Z	M CAPACITOR	.015MF 5% 50V	US
	C 374	QFN31HJ-153Z	M CAPACITOR	.015MF 5% 50V	UF
	C 375	QFV1HJ-334Z	MF CAPACITOR	.33MF 5% 50V	
	C 376	QFV1HJ-334Z	MF CAPACITOR	.33MF 5% 50V	
	C 377	QDVB1EZ-223Y	C CAPACITOR		
	C 378	QDVB1EZ-223Y	C CAPACITOR		
	C 379	QETN1HM-475Z	E CAPACITOR	4.7MF 20% 50V	
	C 380	QETN1HM-475Z	E CAPACITOR	4.7MF 20% 50V	
	C 381	QETN1EM-476Z	E CAPACITOR	47MF 20% 25V	
	C 382	QETN1EM-476Z	E CAPACITOR	47MF 20% 25V	
	C 383	QCF31HZ-223Z	C CAPACITOR	.022MF +80:-20%	
	C 384	QETN1EM-107Z	E CAPACITOR	100MF 20% 25V	
	C 385	QDVB1EZ-223Y	C CAPACITOR		
	C 387	QDVB1EZ-223Y	C CAPACITOR		
	C 388	QDVB1EZ-223Y	C CAPACITOR		
	C 389	QDVB1EZ-223Y	C CAPACITOR		
	C 390	QDVB1EZ-223Y	C CAPACITOR		
	C 391	QCB1HK-471Y	C CAPACITOR	470PF 10% 50V	
	C 392	QFV1HJ-104Z	MF CAPACITOR	.10MF 5% 50V	
	C 393	QETN0JM-477Z	E CAPACITOR	470MF 20% 6.3V	
	C 395	QDGB1HK-102Y	C CAPACITOR		
	CN121	QGB2501J1-12	CONNECTOR		
	CN301	QGB2510K1-15	CONNECTOR		
	CN311	QGB2510J1-15	CONNECTOR		
	CN314	QGF1205C1-29	CONNECTOR		
	CN501	QJB001-091304	C-B WIRE ASSY		UF
	CN501	QJK021-091304	CONN.WIRE ASSY		US
	CN502	QJP010-034001	CONN.WIRE ASSY		US
	CN502	QJF001-03400H	SKT.WIRE ASSY		UF
	CN512	QGA2001C1-03	3P PLUG ASSY		
	CN603	QGB2510K1-07	CONNECTOR		
	CN604	QGB2510K1-07	CONNECTOR		
	CN608	QGB2510K1-04	CONNECTOR		
	CN609	QJF001-03360H	SKT WIRE		UF
	CN609	QJP010-033601	CONN.WIRE ASSY		US
	CN611	QGB2510J1-08	CONNECTOR		
	CN612	QGB2510J1-09	CONNECTOR		

■ Electrical parts list (AV input / output board)

Block No. 03

▲	Item	Parts number	Parts name	Remarks	Area	▲	Item	Parts number	Parts name	Remarks	Area
	CN613	QGB2510J1-07	CONNECTOR				D1531	1SS133-T2	SI DIODE		
	CN614	QGB2510J1-07	CONNECTOR				EP201	E409182-001SM	GRAND TERMINAL		
	CN615	QGB2510J1-06	CONNECTOR				FL141	QQR0590-001	FILTER		
	CN616	QGB2510J1-04	CONNECTOR				FL142	QQR0590-001	FILTER		
	CN618	QGB2510J1-04	CONNECTOR				HL341	VYH7237-003SC	IC HOLDER		
	CN619	QGA2001C1-03	3P PLUG ASSY				IC201	NJM2246D	IC		
	CN702	QJF002-06360H	SOCKET WIRE ASS		UF		IC301	NJM4580D-D	IC		
	CN702	QJP009-063601	CONN.WIRE ASSY		US		IC311	BA15218N	IC		
	C1001	QETN1HM-475Z	E CAPACITOR	4.7MF 20% 50V			IC312	BA15218N	IC		
	C1002	QETN1HM-475Z	E CAPACITOR	4.7MF 20% 50V			IC313	BA15218N	IC		
	C1003	QETN1HM-475Z	E CAPACITOR	4.7MF 20% 50V			IC321	TC9164AN	IC		
	C1004	QETN1HM-475Z	E CAPACITOR	4.7MF 20% 50V			IC322	TC9162AN	IC		
	C1005	QETN1HM-474Z	E CAPACITOR	.47MF 20% 50V			IC323	BU4066BC	IC		
	C1006	QETN1HM-474Z	E CAPACITOR	.47MF 20% 50V			IC331	BA15218	IC		
	C1007	QFN31HJ-223Z	M CAPACITOR	.022MF 5% 50V	UF		IC332	BA15218	IC		
	C1007	QFLC1HJ-223Z	M CAPACITOR	.022MF 5% 50V	US		IC333	BA15218	IC		
	C1008	QFLC1HJ-223Z	M CAPACITOR	.022MF 5% 50V	US		IC341	M62446FP-X	IC		
	C1008	QFN31HJ-223Z	M CAPACITOR	.022MF 5% 50V	UF		IC351	BA15218N	IC		
	C1011	QDVB1EZ-223Y	C CAPACITOR				IC352	BA15218N	IC		
	C1012	QDVB1EZ-223Y	C CAPACITOR				J 211	QNN0180-001	PIN JACK		
	C1013	QCBB1HK-101Y	C CAPACITOR	100PF 10% 50V			J 212	QNN0059-001	PIN JACK	(VCR REC)	
	C1014	QCBB1HK-101Y	C CAPACITOR	100PF 10% 50V			J 213	QNN0059-001	PIN JACK	(VCR PLAY)	
	C1031	QETN1HM-475Z	E CAPACITOR	4.7MF 20% 50V			J 214	QNN0059-001	PIN JACK	(DVD)	
	C1032	QETN1HM-475Z	E CAPACITOR	4.7MF 20% 50V			J 215	QNN0059-001	PIN JACK	(M.OUT)	
	C1033	QETN1HM-475Z	E CAPACITOR	4.7MF 20% 50V			J 301	QNN0163-001	PIN JACK		
	C1034	QETN1HM-475Z	E CAPACITOR	4.7MF 20% 50V			J 302	QNN0163-001	PIN JACK		
	C1035	QETN1HM-475Z	E CAPACITOR	4.7MF 20% 50V			J 303	QNN0163-001	PIN JACK		
	C1036	QETN1HM-475Z	E CAPACITOR	4.7MF 20% 50V			J 311	QNN0060-001	PIN JACK		
	C1038	QETN1HM-475Z	E CAPACITOR	4.7MF 20% 50V			K1001	QQR0601-001Z	FERRITE BEADS		
	C1051	QETN1HM-475Z	E CAPACITOR	4.7MF 20% 50V			K1002	QQR0601-001Z	FERRITE BEADS		
	C1052	QETN1HM-475Z	E CAPACITOR	4.7MF 20% 50V			L1501	QQLZ005-R45	INDUCTOR		
	C1053	QETN1HM-475Z	E CAPACITOR	4.7MF 20% 50V			Q 201	2SC458/CD/-T	TRANSISTOR		
	C1054	QETN1HM-475Z	E CAPACITOR	4.7MF 20% 50V			Q 203	KRC101M-T	TR I/M		
	C1055	QETN1HM-475Z	E CAPACITOR	4.7MF 20% 50V			Q 216	2SC458/CD/-T	TRANSISTOR		
	C1056	QETN1HM-475Z	E CAPACITOR	4.7MF 20% 50V			Q 217	KTA1267/YG/-T	TRANSISTOR		
	C1057	QETN1AM-107Z	E CAPACITOR	100MF 20% 10V			Q 218	KTA1267/YG/-T	TRANSISTOR		
	C1500	QCBB1HK-471Y	C CAPACITOR	470PF 10% 50V			Q 341	2SD2144S/VW/-T	TRANSISTOR		
	C1501	QEHR1HM-106Z	E CAPACITOR	10MF 20% 50V			Q 342	2SD2144S/VW/-T	TRANSISTOR		
	C1502	QCS31HJ-271Z	C CAPACITOR	270PF 5% 50V			Q 351	KRA104M-T	D.TRANSISTOR		
	C1503	QCS11HJ-101	C CAPACITOR	100PF 5% 50V			Q 352	KRC104M-T	D.TRANSISTOR		
	C1504	QCB31HK-152Z	C CAPACITOR	1500PF 10% 50V			Q 353	KRA104M-T	D.TRANSISTOR		
	C1507	QCS11HJ-220	C CAPACITOR	22PF 5% 50V			Q 354	KRA104M-T	D.TRANSISTOR		
	C1508	QEHR1VM-476Z	E CAPACITOR	47MF 20% 35V			Q 361	2SK301/QR/-T	TRANSISTOR(FET)		
	C1511	QEHR1HM-225Z	E CAPACITOR	2.2MF 20% 50V			Q 362	2SK301/QR/-T	TRANSISTOR(FET)		
	C1512	QFN31HJ-103Z	M CAPACITOR	.010MF 5% 50V	UF		Q 363	2SK301/QR/-T	TRANSISTOR(FET)		
	C1512	QFLC1HJ-103Z	M CAPACITOR	.010MF 5% 50V	US		Q 364	2SK301/QR/-T	TRANSISTOR(FET)		
	C1513	QCS32HJ-330Z	C CAPACITOR	33PF 5% 500V			Q 365	2SD2144S/VW/-T	TRANSISTOR		
	C1514	QEHR1HM-476Z	E CAPACITOR	47MF 20% 50V			Q 366	2SD2144S/VW/-T	TRANSISTOR		
	C1517	QEHR2AM-106Z	E CAPACITOR	10MF 20% 100V			Q 367	2SD2144S/VW/-T	TRANSISTOR		
	C1521	QCS32HJ-470Z	C CAPACITOR	47PF 5% 500V			Q 368	2SD2144S/VW/-T	TRANSISTOR		
	C1522	QCS32HJ-470Z	C CAPACITOR	47PF 5% 500V			Q 369	2SD2144S/VW/-T	TRANSISTOR		
	C1543	QFN31HJ-473Z	M CAPACITOR	.047MF 5% 50V	UF		Q 370	2SD2144S/VW/-T	TRANSISTOR		
	C1543	QFLC1HJ-473Z	M CAPACITOR	.047MF 5% 50V	US		Q 371	KRA104M-T	D.TRANSISTOR		
	C1544	QFLC1HJ-473Z	M CAPACITOR	.047MF 5% 50V	US		Q 372	KRA104M-T	D.TRANSISTOR		
	C1544	QFN31HJ-473Z	M CAPACITOR	.047MF 5% 50V	UF		Q 373	KRC104M-T	D.TRANSISTOR		
	D 301	MTZJ7.5C-T2	ZENER DIODE				Q 374	KRA104M-T	D.TRANSISTOR		
	D 302	MTZJ7.5C-T2	ZENER DIODE				Q 376	2SD2144S/VW/-T	TRANSISTOR		
	D 303	MTZJ10C-T2	Z.DIODE				Q 381	2SA965/OY/-T	TRANSISTOR		
	D 304	1SS133-T2	SI DIODE				Q 382	2SC2060/QR/-T	TRANSISTOR		
	D 305	1SS133-T2	SI DIODE				Q 383	2SC2060/QR/-T	TRANSISTOR		
	D1503	1SS133-T2	SI DIODE				Q1501	2SC2240/L/-T	TRANSISTOR		
	D1511	1SS133-T2	SI DIODE				Q1502	2SC2240/L/-T	TRANSISTOR		
	D1512	1SS133-T2	SI DIODE				Q1503	2SA1038S/SE/-T	TRANSISTOR		

■ Electrical parts list (AV input / output board)

Block No. 03

△	Item	Parts number	Parts name	Remarks	Area	△	Item	Parts number	Parts name	Remarks	Area
	Q1509	2SA1038S/SE-T	TRANSISTOR				R 347	QRE141J-221Y	C RESISTOR	220 5% 1/4W	
	Q1511	2SC2389S/SE-T	TRANSISTOR				R 348	QRE141J-221Y	C RESISTOR	220 5% 1/4W	
	Q1512	2SA1038S/SE-T	TRANSISTOR				R 349	QRE141J-103Y	C RESISTOR	10K 5% 1/4W	
	Q1540	2SD637/QR/	TRANSISTOR				R 350	QRE141J-103Y	C RESISTOR	10K 5% 1/4W	
	R 163	QRE141J-472Y	C RESISTOR	4.7K 5% 1/4W		△	R 351	QRJ146J-271X	UNF C.RESISTOR	270 5% 1/4W	
	R 164	QRE141J-472Y	C RESISTOR	4.7K 5% 1/4W		△	R 352	QRJ146J-271X	UNF C.RESISTOR	270 5% 1/4W	
	R 201	QRE141J-471Y	C RESISTOR	470 5% 1/4W			R 353	QRE141J-153Y	C RESISTOR	15K 5% 1/4W	
	R 202	QRE141J-471Y	C RESISTOR	470 5% 1/4W			R 354	QRE141J-153Y	C RESISTOR	15K 5% 1/4W	
	R 203	QRE141J-471Y	C RESISTOR	470 5% 1/4W			R 355	QRE141J-103Y	C RESISTOR	10K 5% 1/4W	
	R 204	QRE141J-471Y	C RESISTOR	470 5% 1/4W			R 356	QRE141J-103Y	C RESISTOR	10K 5% 1/4W	
	R 205	QRE141J-471Y	C RESISTOR	470 5% 1/4W			R 357	QRE141J-102Y	C RESISTOR	1.0K 5% 1/4W	
	R 206	QRE141J-471Y	C RESISTOR	470 5% 1/4W		△	R 361	QRJ146J-271X	UNF C.RESISTOR	270 5% 1/4W	
	R 211	QRE141J-750Y	C RESISTOR	75 5% 1/4W		△	R 362	QRJ146J-271X	UNF C.RESISTOR	270 5% 1/4W	
	R 212	QRE141J-473Y	C RESISTOR	47K 5% 1/4W			R 363	QRE141J-432Y	C RESISTOR	4.3K 5% 1/4W	
	R 213	QRE141J-331Y	C RESISTOR	330 5% 1/4W			R 364	QRE141J-562Y	C RESISTOR	5.6K 5% 1/4W	
	R 214	QRE141J-750Y	C RESISTOR	75 5% 1/4W			R 365	QRE141J-102Y	C RESISTOR	1.0K 5% 1/4W	
	R 215	QRE141J-331Y	C RESISTOR	330 5% 1/4W			R 366	QRE141J-102Y	C RESISTOR	1.0K 5% 1/4W	
	R 216	QRE141J-750Y	C RESISTOR	75 5% 1/4W			R 367	QRE141J-104Y	C RESISTOR	100K 5% 1/4W	
	R 217	QRE141J-750Y	C RESISTOR	75 5% 1/4W			R 368	QRE141J-104Y	C RESISTOR	100K 5% 1/4W	
	R 218	QRE141J-473Y	C RESISTOR	47K 5% 1/4W			R 371	QRE141J-102Y	C RESISTOR	1.0K 5% 1/4W	
	R 221	QRE141J-151Y	C RESISTOR	150 5% 1/4W			R 372	QRE141J-103Y	C RESISTOR	10K 5% 1/4W	
	R 222	QRE141J-151Y	C RESISTOR	150 5% 1/4W			R 373	QRE141J-103Y	C RESISTOR	10K 5% 1/4W	
	R 223	QRE141J-151Y	C RESISTOR	150 5% 1/4W			R 375	QRE141J-104Y	C RESISTOR	100K 5% 1/4W	
	R 224	QRE141J-152Y	C RESISTOR	1.5K 5% 1/4W			R 376	QRE141J-104Y	C RESISTOR	100K 5% 1/4W	
	R 225	QRE141J-151Y	C RESISTOR	150 5% 1/4W			R 377	QRE141J-333Y	C RESISTOR	33K 5% 1/4W	
	R 227	QRE141J-152Y	C RESISTOR	1.5K 5% 1/4W			R 378	QRE141J-333Y	C RESISTOR	33K 5% 1/4W	
△	R 271	QRJ146J-6R8X	UNF C.RESISTOR	6.8 5% 1/4W			R 379	QRE141J-333Y	C RESISTOR	33K 5% 1/4W	
	R 301	QRE141J-222Y	C RESISTOR	2.2K 5% 1/4W			R 381	QRE141J-363Y	C RESISTOR	36K 5% 1/4W	
	R 302	QRE141J-222Y	C RESISTOR	2.2K 5% 1/4W			R 382	QRE141J-363Y	C RESISTOR	36K 5% 1/4W	
	R 303	QRE141J-473Y	C RESISTOR	47K 5% 1/4W			R 383	QRE141J-103Y	C RESISTOR	10K 5% 1/4W	
	R 304	QRE141J-473Y	C RESISTOR	47K 5% 1/4W			R 384	QRE141J-103Y	C RESISTOR	10K 5% 1/4W	
	R 305	QRE141J-561Y	C RESISTOR	560 5% 1/4W			R 385	QRE141J-104Y	C RESISTOR	100K 5% 1/4W	
	R 306	QRE141J-561Y	C RESISTOR	560 5% 1/4W			R 386	QRE141J-104Y	C RESISTOR	100K 5% 1/4W	
	R 307	QRE141J-393Y	C RESISTOR	39K 5% 1/4W		△	R 391	QRJ146J-220X	UNF C.RESISTOR	22 5% 1/4W	
	R 308	QRE141J-393Y	C RESISTOR	39K 5% 1/4W			R 392	QRE141J-102Y	C RESISTOR	1.0K 5% 1/4W	
	R 309	QRE141J-474Y	C RESISTOR	470K 5% 1/4W			R 393	QRE141J-472Y	C RESISTOR	4.7K 5% 1/4W	
	R 310	QRE141J-474Y	C RESISTOR	470K 5% 1/4W			R 394	QRE141J-472Y	C RESISTOR	4.7K 5% 1/4W	
	R 311	QRE141J-104Y	C RESISTOR	100K 5% 1/4W		△	R 395	QRJ146J-8R2X	UNF C.RESISTOR	8.2 5% 1/4W	
	R 312	QRE141J-104Y	C RESISTOR	100K 5% 1/4W			R1001	QRE141J-103Y	C RESISTOR	10K 5% 1/4W	
△	R 313	QRJ146J-391X	UNF C.RESISTOR	390 5% 1/4W			R1002	QRE141J-103Y	C RESISTOR	10K 5% 1/4W	
△	R 314	QRJ146J-391X	UNF C.RESISTOR	390 5% 1/4W			R1003	QRE141J-154Y	C RESISTOR	150K 5% 1/4W	
	R 321	QRE141J-271Y	C RESISTOR	270 5% 1/4W			R1004	QRE141J-154Y	C RESISTOR	150K 5% 1/4W	
	R 322	QRE141J-271Y	C RESISTOR	270 5% 1/4W			R1005	QRE141J-102Y	C RESISTOR	1.0K 5% 1/4W	
	R 323	QRE141J-102Y	C RESISTOR	1.0K 5% 1/4W			R1006	QRE141J-102Y	C RESISTOR	1.0K 5% 1/4W	
	R 325	QRE141J-471Y	C RESISTOR	470 5% 1/4W			R1007	QRE141J-103Y	C RESISTOR	10K 5% 1/4W	
	R 326	QRE141J-471Y	C RESISTOR	470 5% 1/4W			R1008	QRE141J-103Y	C RESISTOR	10K 5% 1/4W	
	R 327	QRE141J-471Y	C RESISTOR	470 5% 1/4W			R1009	QRE141J-103Y	C RESISTOR	10K 5% 1/4W	
	R 328	QRE141J-471Y	C RESISTOR	470 5% 1/4W			R1010	QRE141J-103Y	C RESISTOR	10K 5% 1/4W	
	R 329	QRE141J-471Y	C RESISTOR	470 5% 1/4W			R1011	QRE141J-103Y	C RESISTOR	10K 5% 1/4W	
	R 330	QRE141J-471Y	C RESISTOR	470 5% 1/4W			R1012	QRE141J-103Y	C RESISTOR	10K 5% 1/4W	
	R 331	QRE141J-471Y	C RESISTOR	470 5% 1/4W			R1013	QRE141J-103Y	C RESISTOR	10K 5% 1/4W	
	R 332	QRE141J-471Y	C RESISTOR	470 5% 1/4W			R1014	QRE141J-103Y	C RESISTOR	10K 5% 1/4W	
	R 333	QRE141J-471Y	C RESISTOR	470 5% 1/4W			R1015	QRE141J-272Y	C RESISTOR	2.7K 5% 1/4W	
	R 334	QRE141J-471Y	C RESISTOR	470 5% 1/4W			R1016	QRE141J-272Y	C RESISTOR	2.7K 5% 1/4W	
	R 335	QRE141J-471Y	C RESISTOR	470 5% 1/4W			R1017	QRE141J-472Y	C RESISTOR	4.7K 5% 1/4W	
	R 336	QRE141J-471Y	C RESISTOR	470 5% 1/4W			R1018	QRE141J-472Y	C RESISTOR	4.7K 5% 1/4W	
	R 337	QRE141J-102Y	C RESISTOR	1.0K 5% 1/4W			R1019	QRE141J-513Y	C RESISTOR	51K 5% 1/4W	
	R 341	QRE141J-104Y	C RESISTOR	100K 5% 1/4W			R1020	QRE141J-513Y	C RESISTOR	51K 5% 1/4W	
	R 342	QRE141J-104Y	C RESISTOR	100K 5% 1/4W		△	R1021	QRZ9005-680X	F.RESISTOR	68 1/0W	
	R 343	QRE141J-104Y	C RESISTOR	100K 5% 1/4W		△	R1022	QRZ9005-680X	F.RESISTOR	68 1/0W	
	R 344	QRE141J-104Y	C RESISTOR	100K 5% 1/4W			R1023	QRE141J-102Y	C RESISTOR	1.0K 5% 1/4W	
	R 345	QRE141J-511Y	C RESISTOR	510 5% 1/4W			R1024	QRE141J-103Y	C RESISTOR	10K 5% 1/4W	
	R 346	QRE141J-511Y	C RESISTOR	510 5% 1/4W			R1025	QRE141J-103Y	C RESISTOR	10K 5% 1/4W	

■ Electrical parts list (AV input / output board)

Block No. 03

△	Item	Parts number	Parts name	Remarks	Area
	R1031	QRE141J-104Y	C RESISTOR	100K 5% 1/4W	
	R1032	QRE141J-104Y	C RESISTOR	100K 5% 1/4W	
	R1033	QRE141J-104Y	C RESISTOR	100K 5% 1/4W	
	R1034	QRE141J-104Y	C RESISTOR	100K 5% 1/4W	
	R1035	QRE141J-104Y	C RESISTOR	100K 5% 1/4W	
	R1036	QRE141J-104Y	C RESISTOR	100K 5% 1/4W	
	R1037	QRE141J-102Y	C RESISTOR	1.0K 5% 1/4W	
	R1038	QRE141J-102Y	C RESISTOR	1.0K 5% 1/4W	
	R1039	QRE141J-103Y	C RESISTOR	10K 5% 1/4W	
	R1040	QRE141J-103Y	C RESISTOR	10K 5% 1/4W	
	R1041	QRE141J-103Y	C RESISTOR	10K 5% 1/4W	
	R1042	QRE141J-273Y	C RESISTOR	27K 5% 1/4W	
	R1044	QRE141J-102Y	C RESISTOR	1.0K 5% 1/4W	
	R1045	QRE141J-102Y	C RESISTOR	1.0K 5% 1/4W	
	R1046	QRE141J-104Y	C RESISTOR	100K 5% 1/4W	
△	R1049	QRZ9005-680X	F.RESISTOR	68 1/0W	
△	R1050	QRZ9005-680X	F.RESISTOR	68 1/0W	
	R1051	QRE141J-104Y	C RESISTOR	100K 5% 1/4W	
	R1052	QRE141J-104Y	C RESISTOR	100K 5% 1/4W	
	R1053	QRE141J-104Y	C RESISTOR	100K 5% 1/4W	
	R1054	QRE141J-104Y	C RESISTOR	100K 5% 1/4W	
	R1055	QRE141J-104Y	C RESISTOR	100K 5% 1/4W	
	R1056	QRE141J-104Y	C RESISTOR	100K 5% 1/4W	
	R1057	QRE141J-102Y	C RESISTOR	1.0K 5% 1/4W	
	R1058	QRE141J-102Y	C RESISTOR	1.0K 5% 1/4W	
	R1059	QRE141J-103Y	C RESISTOR	10K 5% 1/4W	
	R1060	QRE141J-103Y	C RESISTOR	10K 5% 1/4W	
	R1061	QRE141J-102Y	C RESISTOR	1.0K 5% 1/4W	
	R1062	QRE141J-104Y	C RESISTOR	100K 5% 1/4W	
	R1063	QRE141J-104Y	C RESISTOR	100K 5% 1/4W	
	R1064	QRE141J-104Y	C RESISTOR	100K 5% 1/4W	
	R1065	QRE141J-102Y	C RESISTOR	1.0K 5% 1/4W	
△	R1071	QRZ9005-100X	F.RESISTOR	10 1/0W	
△	R1072	QRJ146J-222X	UNF C.RESISTOR	2.2K 5% 1/4W	
△	R1073	QRZ9005-100X	F.RESISTOR	10 1/0W	
△	R1074	QRJ146J-222X	UNF C.RESISTOR	2.2K 5% 1/4W	
△	R1075	QRZ9005-100X	F.RESISTOR	10 1/0W	
△	R1076	QRJ146J-102X	UNF C.RESISTOR	1.0K 5% 1/4W	
	R1501	QRE141J-222Y	C RESISTOR	2.2K 5% 1/4W	
	R1502	QRE141J-563Y	C RESISTOR	56K 5% 1/4W	
	R1503	QRE141J-302Y	C RESISTOR	3.0K 5% 1/4W	
	R1504	QRE141J-101Y	C RESISTOR	100 5% 1/4W	
	R1505	QRE141J-183Y	C RESISTOR	18K 5% 1/4W	
	R1507	QRE141J-563Y	C RESISTOR	56K 5% 1/4W	
	R1508	QRE141J-391Y	C RESISTOR	390 5% 1/4W	
△	R1511	QRJ146J-331X	UNF C.RESISTOR	330 5% 1/4W	
	R1512	QRE141J-332Y	C RESISTOR	3.3K 5% 1/4W	
	R1513	QRE141J-332Y	C RESISTOR	3.3K 5% 1/4W	
	R1514	QRE141J-332Y	C RESISTOR	3.3K 5% 1/4W	
	R1515	QRE141J-332Y	C RESISTOR	3.3K 5% 1/4W	
△	R1517	QRJ146J-100X	UNF.C RESISTOR	10 5% 1/4W	
△	R1518	QRJ146J-100X	UNF.C RESISTOR	10 5% 1/4W	
△	R1523	QRJ146J-100X	UNF.C RESISTOR	10 5% 1/4W	
△	R1524	QRJ146J-100X	UNF.C RESISTOR	10 5% 1/4W	
△	R1527	QRZ0196-R22	EMIT.RESISTOR	1/1W	
△	R1528	QRJ125J-330	UNF.C.RESISTOR	33 5% 1/2W	
	R1531	QRE141J-102Y	C RESISTOR	1.0K 5% 1/4W	
	R1532	QRE141J-183Y	C RESISTOR	18K 5% 1/4W	
	R1533	QRE141J-123Y	C RESISTOR	12K 5% 1/4W	
	R1541	QRE141J-471Y	C RESISTOR	470 5% 1/4W	
	R1542	QRE141J-361Y	C RESISTOR	360 5% 1/4W	
	R1543	QRE141J-181Y	C RESISTOR	180 5% 1/4W	
	R1544	QRE141J-181Y	C RESISTOR	180 5% 1/4W	

△	Item	Parts number	Parts name	Remarks	Area
	R1545	QRE141J-181Y	C RESISTOR	180 5% 1/4W	
	R1546	QRE141J-181Y	C RESISTOR	180 5% 1/4W	
△	R1547	QRL022J-100	UNF.OMF.RES.	10 5% 1/2W	
	R1549	QRE141J-301Y	C RESISTOR	300 5% 1/4W	
△	TH541	QAD0012-202	THERMISTOR		

■ Electrical parts list (Tuner board)

Block No. 04

△	Item	Parts number	Parts name	Remarks	Area
	AT101	QNB0014-001	ANT TERMINAL		
	BK 1	LV31618-001A	SHIELD BKT		
	C 101	NCB21HK-103X	C CAPACITOR		
	C 103	NCB21HK-223X	C CAPACITOR		
	C 105	NCB21HK-223X	C CAPACITOR		
	C 107	QEK1CM-226Z	E CAPACITOR	22MF 20% 16V	
	C 111	NCB21HK-473X	C CAPACITOR		
	C 112	NDC21HJ-120X	C CAPACITOR		
	C 121	NDC21HJ-120X	C CAPACITOR		
	C 122	NDC21HJ-120X	C CAPACITOR		
	C 123	NCB21HK-473X	C CAPACITOR		
	C 126	NCS21HJ-101X	C CAPACITOR		
	C 128	QENC1HM-474Z	NP E.CAPACITOR	.47MF 20% 50V	
	C 129	NCB21HK-102X	C CAPACITOR		
	C 130	QEK1AM-107Z	E CAPACITOR	100MF 20% 10V	
	C 133	QEK1CM-226Z	E CAPACITOR	22MF 20% 16V	
	C 134	NCB21HK-222X	C CAPACITOR		
	C 135	NCB21HK-223X	C CAPACITOR		
	C 136	QEK1HM-105Z	E CAPACITOR	1.0MF 20% 50V	
	C 137	NCB21HK-331X	C CAPACITOR		
	C 138	NCB21HK-473X	C CAPACITOR		
	C 139	NCB21HK-223X	C CAPACITOR		
	C 140	NCB21HK-223X	C CAPACITOR		
	C 141	NCB21HK-473X	C CAPACITOR		
	C 143	NCB21HK-223X	C CAPACITOR		
	C 144	NCB21HK-473X	C CAPACITOR		
	C 146	QEK1HM-105Z	E CAPACITOR	1.0MF 20% 50V	
	C 147	QEK1HM-105Z	E CAPACITOR	1.0MF 20% 50V	
	C 148	QEK1HM-224Z	E CAPACITOR	.22MF 20% 50V	
	C 149	QEK1HM-105Z	E CAPACITOR	1.0MF 20% 50V	
	C 150	QEK1CM-226Z	E CAPACITOR	22MF 20% 16V	
	C 156	QDGB1HK-102Y	C CAPACITOR		
	C 157	NCB21HK-473X	C CAPACITOR		
	C 158	QEK1CM-226Z	E CAPACITOR	22MF 20% 16V	
	C 161	QEK41CM-106	E CAPACITOR	10MF 20% 16V	
	C 162	QEK41CM-106	E CAPACITOR	10MF 20% 16V	
	C 163	NCB21HK-223X	C CAPACITOR		
	C 164	NCB21HK-473X	C CAPACITOR		
	C 168	QEK1HM-105Z	E CAPACITOR	1.0MF 20% 50V	
	C 184	QEK1CM-107Z	E CAPACITOR	100MF 20% 16V	
	C 185	QEK41CM-106	E CAPACITOR	10MF 20% 16V	
	C 186	QEK41CM-106	E CAPACITOR	10MF 20% 16V	
	CF101	QAX0419-001Z	C FILTER		
	CF102	QAX0604-001Z	C FILTER		
	CF103	QAX0519-001Z	C FILTER		
	CN111	QGB2501K2-12	CONNECTOR		
	D 121	1SS133-T2	SI DIODE		
	D 123	1SS133-T2	SI DIODE		
	D 129	1SS133-T2	SI DIODE		
	IC102	LA1838	IC		
	IC121	LC72136N	IC		
	Q 102	2SC535/BC-T	TRANSISTOR		
	Q 103	2SC461/BC-T	TRANSISTOR		
	Q 121	KRA103M-T	TRANSISTOR		
	R 103	NRSA02J-221X	MG RESISTOR		
	R 104	NRSA02J-272X	MG RESISTOR		
	R 105	NRSA02J-391X	MG RESISTOR		
	R 106	NRSA02J-102X	MG RESISTOR		
	R 107	NRSA02J-391X	MG RESISTOR		
	R 108	NRSA02J-332X	MG RESISTOR		
	R 109	NRSA02J-221X	MG RESISTOR		
	R 115	NRSA02J-104X	MG RESISTOR		
	R 119	NRSA02J-103X	MG RESISTOR		

△	Item	Parts number	Parts name	Remarks	Area
	R 122	NRSA02J-472X	MG RESISTOR		
	R 124	NRSA02J-222X	MG RESISTOR		
	R 126	NRSA02J-562X	MG RESISTOR		
	R 127	NRSA02J-822X	MG RESISTOR		
	R 128	NRSA02J-472X	MG RESISTOR		
	R 129	NRSA02J-222X	MG RESISTOR		
△	R 130	QRZ9005-680X	F RESISTOR	68 1/0W	
	R 132	NRSA02J-393X	MG RESISTOR		
	R 133	NRSA02J-392X	MG RESISTOR		
	R 134	NRSA02J-102X	MG RESISTOR		
	R 140	NRSA02J-183X	MG RESISTOR		
	R 141	NRSA02J-102X	MG RESISTOR		
	R 142	NRSA02J-470X	MG RESISTOR		
	R 143	NRSA02J-562X	MG RESISTOR		
	R 144	NRSA02J-332X	MG RESISTOR		
	R 145	NRSA02J-103X	MG RESISTOR		
	R 146	NRSA02J-392X	MG RESISTOR		
	R 147	NRSA02J-332X	MG RESISTOR		
	R 150	NRSA02J-331X	MG RESISTOR		
	R 157	NRSA02J-682X	MG RESISTOR		
	R 158	NRSA02J-682X	MG RESISTOR		
	R 161	NRSA02J-102X	MG RESISTOR		
	R 162	NRSA02J-102X	MG RESISTOR		
	R 182	NRSA02J-103X	MG RESISTOR		
	R 183	NRSA02J-103X	MG RESISTOR		
	R 184	NRSA02J-103X	MG RESISTOR		
	RF101	QAU0124-002	FRONT END		
	T 111	QQR0796-001	COIL BLOCK		
	T 142	QQR0973-001	IFT		
	X 121	QAX0402-001	CRYSTAL		

Packing materials and accessories parts list

Block No. M 2 M M

Block No. M 3 M M

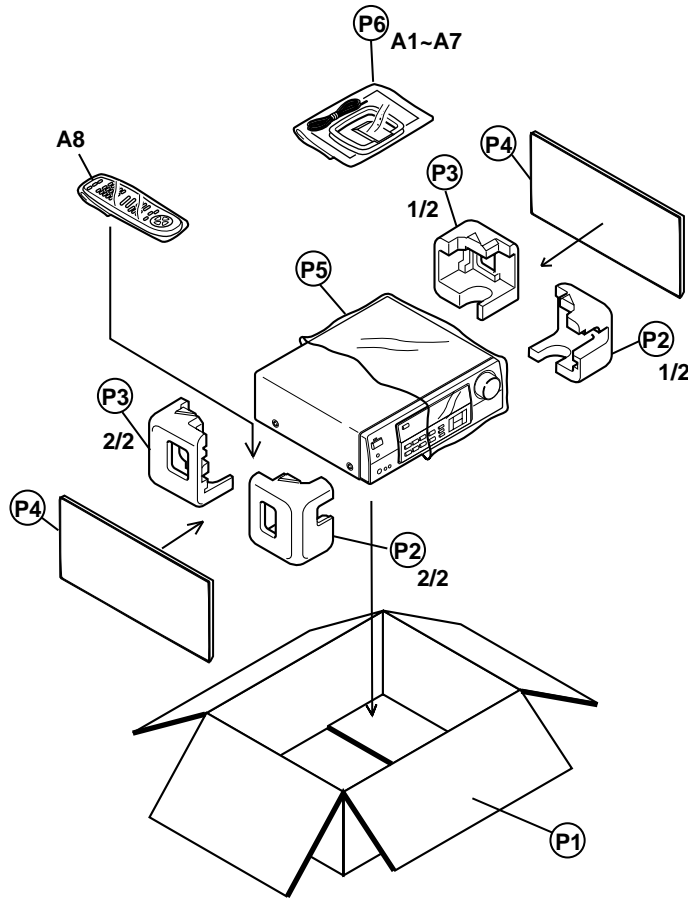

Parts list (Packing)

Block No. M2MM

Item	Parts number	Parts name	Q'ty	Description	Area
P 1	LV30044-0E4A	PACKING CASE	1	RX-5001VGD	US
	LV20806-001A	PACKING CASE	1	RX-5000VBK	UF
	LV20806-002A	PACKING CASE	1	RX-5001VGD	UF
P 2	LV20231-001A	PACKING PAD(F)	1		US
	LV20231-201A	PACKING PAD(F)	1		UF
P 3	LV20232-001A	PACKING PAD(R)	1		US
	LV20232-201A	PACKING PAD(R)	1		UF
P 4	LV32034-001A	PACKING SHEET	2		US
P 5	LV40363-001A	POLY BAG	1	RX-5001VGD	
	QPC06507015P	POLY BAG	1	RX-5000VBK	
P 6	QPA02503505P	POLY BAG	1		

Parts list (Accessories)

Block No. M3MM

Item	Parts number	Parts name	Q'ty	Description	Area
A 1	LVT0384-009A	INST.BOOK	1	CHI	UF
	LVT0384-006A	INST.BOOK	1	ENG,SPA,POR,CHI	US
A 2	BT-59009-1	SVC CENTER LIST	1		UF
A 3	BT-59007-2	WARRANTY CARD	1		UF
A 4	EWP503-001C	ANT.WIRE	1		
A 5	QAL0014-001	AM LOOP ANT	1		UF
	QAL0204-001	AM LOOP ANT	1		US
A 6	QAM0054-001	AC PLUGADAPTER	1		
A 7	-----	BATTERY	1		
A 8	RM-SR558XU	REMOCON	1		

RX-5000VBK
RX-5001VGD

JVC

VICTOR COMPANY OF JAPAN, LIMITED

AUDIO & COMMUNICATION BUSINESS DIVISION

PERSONAL & MOBILE NETWORK BUSINESS UNIT. 10-1,1Chome,Ohwatari-machi,maebashi-city,371-8543,Japan

JVC



AUDIO/VIDEO CONTROL RECEIVER

RECEPTOR DE CONTROL DE AUDIO/VÍDEO
RECEPTOR DE COMANDO AUDIO/VÍDEO

AV功率放大器（带收音）

RX-5000VBK / RX-5001VGD

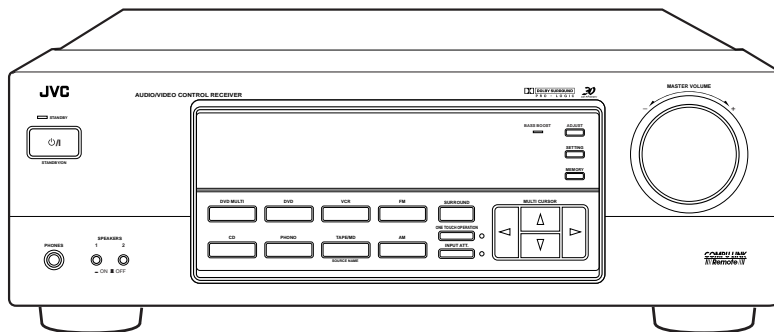
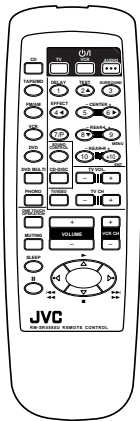

COMPU LINK
Remote

3D
3D-PHONIC

DOLBY SURROUND
PRO • LOGIC

INSTRUCTIONS

MANUAL DE INSTRUCCIONES
INSTRUÇÕES
使用说明书

For Customer Use:

Enter below the Model No. and Serial No. which are located either on the rear, bottom or side of the cabinet. Retain this information for future reference.

Model No. _____

Serial No. _____

LVT0384-006A
[U, US]

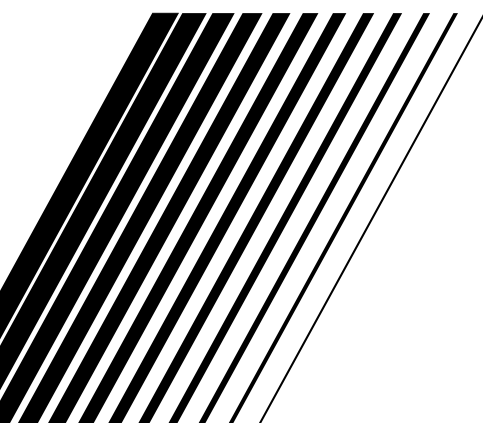

Warnings, Cautions and Others / Avisos, precauciones y otras notas / Advertências, precauções e outras notas / 警告、注意及其他須知事項 تحذيرات، تنبيهات وأشياء أخرى

CAUTION

To reduce the risk of electrical shocks, fire, etc.:

1. Do not remove screws, covers or cabinet.
2. Do not expose this appliance to rain or moisture.

PRECAUCIÓN

Para reducir riesgos de choques eléctricos, incendio, etc.:

1. No extraiga los tornillos, los cubiertas ni la caja.
2. No exponga este aparato a la lluvia o a la humedad.

ATENÇÃO

Para reduzir riscos de choques eléctricos, incêndio, etc.:

1. Não retire parafusos nem desmonte as tampas ou o gabinete.
2. Não exponha este aparelho à chuva nem à umidade.

警告

为了减低触电，火灾等危险：

1. 请勿擅自卸下螺丝钉，盖子或机壳。
2. 切勿让本机受雨淋或置潮湿环境中。

تحذير

لتجنب خطر الحريق، الصدمات الكهربائية، الخ.:

1. لا تقم بفك البراغي، الاغطية أو الخزانة.
2. لا تقم بتعرض هذا الجهاز للمطر أو للرطوبة.

Caution — ⏻/I switch!

Disconnect the mains plug to shut the power off completely. The ⏻/I switch in any position does not disconnect the mains line. The power can be remote controlled.

Precaución — Interruptor ⏻/I!

Desconectar el cable de alimentación para desactivar la alimentación totalmente. Cualquiera que sea la posición de ajuste del interruptor ⏻/I, la alimentación no es cortada completamente. La alimentación puede ser controlada remotamente.

Precaução — Interruptor ⏻/I!

Desconectar o cabo de alimentação para desligar a alimentação por completo. Qualquer que seja a posição de ajuste do interruptor ⏻/I, a alimentação não é completamente cortada. A alimentação pode ser controlada remotamente.

注意 — ⏻/I 按键

无论 ⏻/I 按键在任何位置，电源线的电源还是没有被切断，若要将电源完全关闭，应把电源插头拔离插座。电源可用遥控器控制。

تحذير — ⏻/I الطاقة

انزع قابس الطاقة الكهربائية من اجل فصل الطاقة الكهربائية عن الجهاز كلياً. لا يفصل مفتاح الطاقة الكهربائية عندما يكون باي وضع ⏻/I الطاقة الكهربائية عن الجهاز. يمكن التحكم عن بعد بالطاقة الكهربائية.

Caution: Proper Ventilation

To avoid risk of electric shock and fire and to protect from damage.

Locate the apparatus as follows:

- Front: No obstructions open spacing.
 Sides: No obstructions in 10 cm from the sides.
 Top: No obstructions in 10 cm from the top.
 Back: No obstructions in 15 cm from the back.
 Bottom: No obstructions, place on the level surface.

In addition, maintain the best possible air circulation as illustrated.

Precaución: Ventilación Adecuada

Para evitar el riesgo de choque eléctrico e incendio y para proteger el aparato contra daños.

Ubique el aparato de la siguiente manera:

- Frente: Espacio abierto sin obstrucciones
 Lados: 10 cm sin obstrucciones a los lados
 Parte superior: 10 cm sin obstrucciones en la parte superior
 Parte trasera: 15 cm sin obstrucciones en la parte trasera
 Fondo: Sin obstrucciones, colóquelo sobre una superficie nivelada

Además, mantenga la mejor circulación de aire posible como se ilustra.

Precaução: ventilação apropriada

Para prevenir o risco de choque elétrico ou incêndio e para proteger o aparelho contra danos.

Localize-o da seguinte maneira:

- Frente: Espaço aberto, sem obstruções
 Lados: Espaço de 10 cm sem obstruções nos lados
 Topo: Espaço de 10 cm sem obstruções acima
 Atrás: Espaço de 15 cm sem obstruções atrás
 Parte inferior: Sem obstruções. Coloque o aparelho em superfície nivelada.

Mantenha, além disso, a maior circulação de ar possível, como indica a ilustração.

注意：正确的通风方法

为了防止触电、火灾以及避免损坏，

按如下要求放置机器：

- 前面：留下空间不要放置障碍物。
 侧面：侧面的10cm之内不要放置障碍物。
 上面：上面的10cm之内不要放置障碍物。
 背面：背面的15cm之内不要放置障碍物。
 底部：不要放置障碍物，水平放置。

此外、如图所示，尽可能保持最佳的空气循环。

تنبيه: حول التهوية الصحيحة

لتفادي وقوع الصدمة الكهربائية والحريق، ولحماية الأجهزة من التلف قم بتحديد مواقع تركيب الأجهزة كالتالي:

- الامام: مساحة فارغة بدون عوائق
 الجوانب: عدم وجود أية عوائق بطول ١٠ سم من الجوانب
 السطح العلوي: عدم وجود أية عوائق بطول ١٠ سم من السطح العلوي
 الخلف: عدم وجود أية عوائق بطول ١٥ سم من اللوحة الخلفية
 القاع: عدم وجود أية عوائق، يجب وضع الأجهزة على السطح المستوي.
 بالإضافة الى ذلك، احتفظ بأفضل توزيع للهواء كما هو مبين في الرسم.

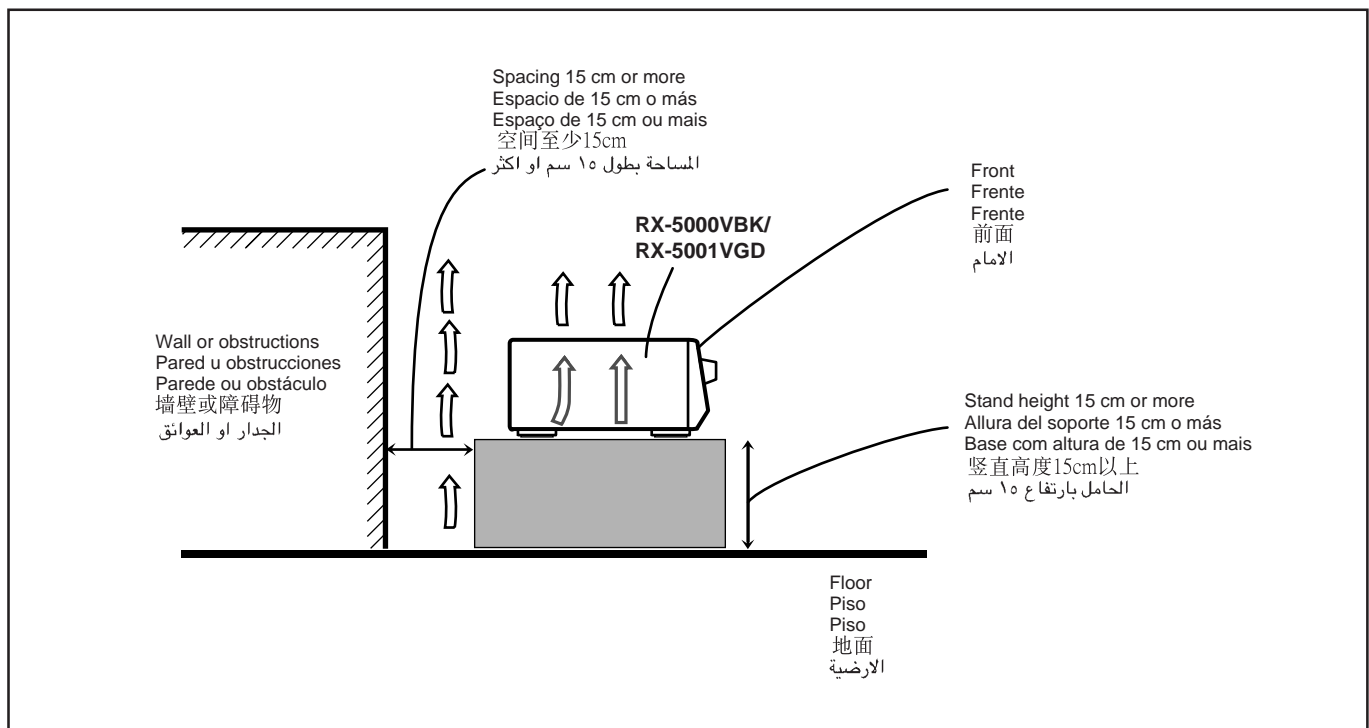
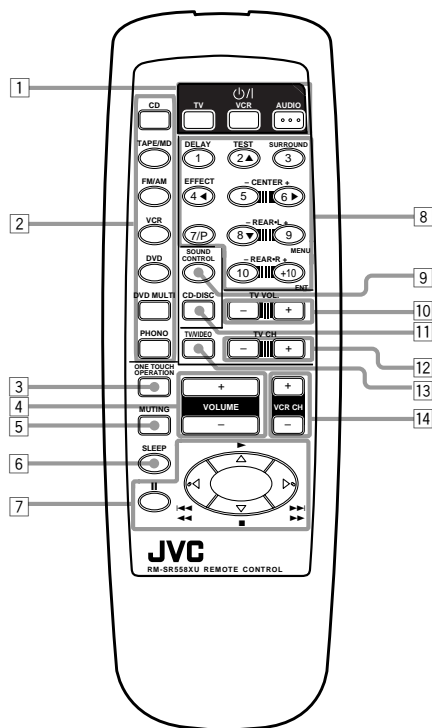
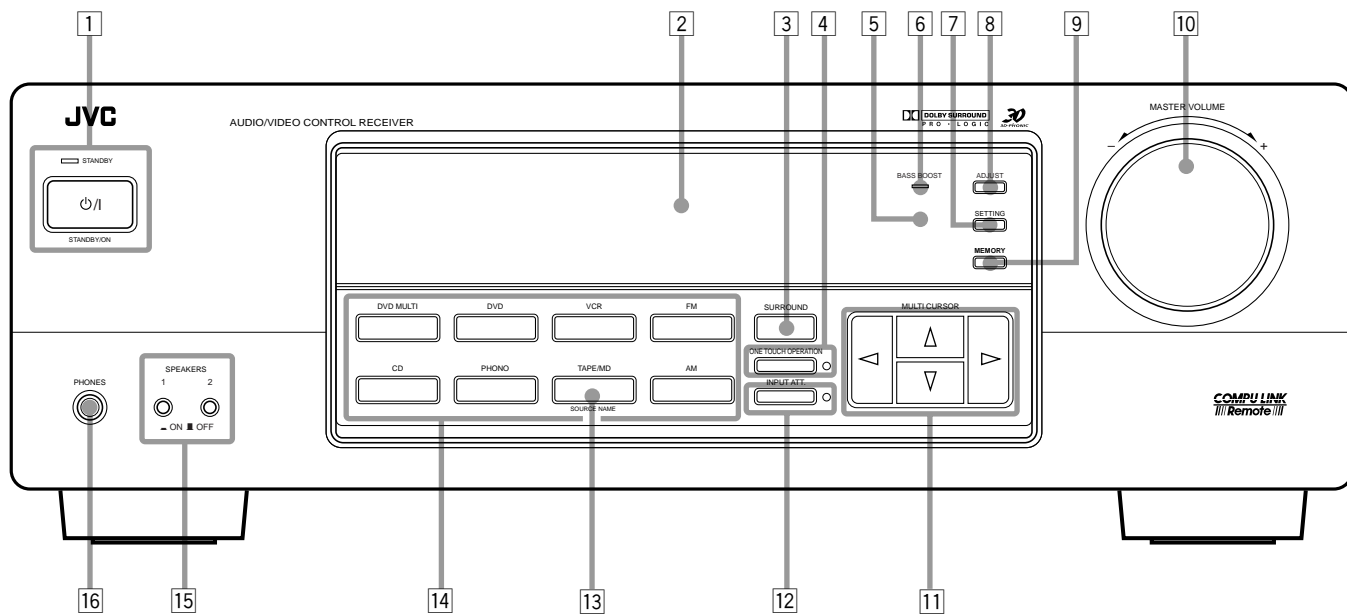

Table of Contents

Parts Identification	2
Getting Started	3
Before Installation	3
Checking the Supplied Accessories	3
Connecting the FM and AM Antennas	3
Connecting the Speakers	4
Connecting Audio/Video Components	5
Connecting the Power Cord	7
Putting Batteries in the Remote Control	7
Basic Operations	8
Turning the Power On and Off (Standby)	8
Selecting the Source to Play	8
Adjusting the Volume	9
Selecting the Front Speakers	9
Muting the Sound	9
Recording a Source	9
Attenuating the Input Signal	10
Adjusting the Front Speaker Output Balance	10
Reinforcing the Bass	10
Adjusting the Tone	10
Basic Settings	11
Changing the Source Name	11
Setting Center and Rear Speakers for the DSP Modes	11
Storing the Basic Settings and Adjustments — One Touch Operation	12
Using the Sleep Timer	12
Receiving Radio Broadcasts	13
Setting the AM Tuner Internal Spacing	13
Tuning in Stations Manually	13
Using Preset Tuning	13
Selecting the FM Reception Mode	14
Using the DSP Modes	15
Available DSP Modes According to the Speaker Arrangement ..	16
Adjusting the 3D-PHONIC Modes	17
Adjusting the DAP Modes	17
Adjusting the Surround Modes — Dolby Surround and JVC Theater Surround	18
Activating the DSP Modes	19
Using the DVD MULTI Playback Mode	20
Activating the DVD MULTI Playback Mode	20
COMPU LINK Remote Control System	21
Operating JVC's Audio/Video Components ...	22
Troubleshooting	24
Specifications	25

Parts Identification

Become familiar with the buttons and controls on the receiver before use.
Refer to the pages in parentheses for details.



Front Panel

- 1 STANDBY/ON \odot/I button and STANDBY lamp (8)
- 2 Display (8)
- 3 SURROUND button (16)
- 4 ONE TOUCH OPERATION button and lamp (12)
- 5 Remote sensor (7)
- 6 BASS BOOST lamp (10)
- 7 SETTING button (11)*
- 8 ADJUST button (10)*
- 9 MEMORY button (13)
- 10 MASTER VOLUME control (9)
- 11 Cursor control buttons
- 12 INPUT ATT. button and lamp (10)
- 13 SOURCE NAME button (11)
- 14 Source selecting buttons (8)
DVD MULTI, DVD, VCR, FM*, AM*,
TAPE/MD, PHONO, CD
- 15 SPEAKERS 1/2 buttons (9)
- 16 PHONES jack (9)

Remote Control

- 1 \odot/I buttons (8, 23)
TV, VCR, AUDIO
- 2 Source selecting buttons (8)
CD, TAPE/MD, FM/AM, VCR, DVD,
DVD MULTI, PHONO
- 3 ONE TOUCH OPERATION button (12)
- 4 VOLUME +/- buttons (9)
- 5 MUTING button (9)
- 6 SLEEP button (12)
- 7 • Operating buttons for audio/video components (22)
- 8 • 10 keys for selecting preset channel (14, 22)
• 10 keys for adjusting sound (12, 17, 22)
• 10 keys for operating audio/video components (22)
- 9 SOUND CONTROL button (12, 17, 22)
- 10 TV VOL. +/- buttons (23)
- 11 CD-DISC button (22)
- 12 TV CH +/- buttons (23)
- 13 TV/VIDEO button (23)
- 14 VCR CH +/- buttons (23)

IMPORTANT:

To use the Cursor control buttons (11) on the front panel:

What these buttons actually do depends on which function you are trying to adjust. Before using these buttons, select the function by pressing one of the buttons marked with *.

Getting Started

This section explains how to connect audio/video components and speakers to the receiver, and how to connect the power supply.

Before Installation

General

- Be sure your hands are dry.
- Turn the power off to all components.
- Read the manuals supplied with the components you are going to connect.

Locations

- Install the receiver in a location that is level and protected from moisture.
- The temperature around the receiver must be between -5°C and 35°C (23°F and 95°F).
- Make sure there is good ventilation around the receiver. Poor ventilation could cause overheating and damage the receiver.

Handling the receiver

- Do not insert any metal object into the receiver.
- Do not disassemble the receiver or remove screws, covers, or cabinet.
- Do not expose the receiver to rain or moisture.

Checking the Supplied Accessories

Check to be sure you have all of the following items, which are supplied with the receiver.

The number in the parentheses indicates quantity of the pieces supplied.

- **Remote Control (1)**
- **Batteries (2)**
- **AM Loop Antenna (1)**
- **FM Antenna (1)**

If anything is missing, contact your dealer immediately.

Connecting the FM and AM Antennas

FM Antenna Connections

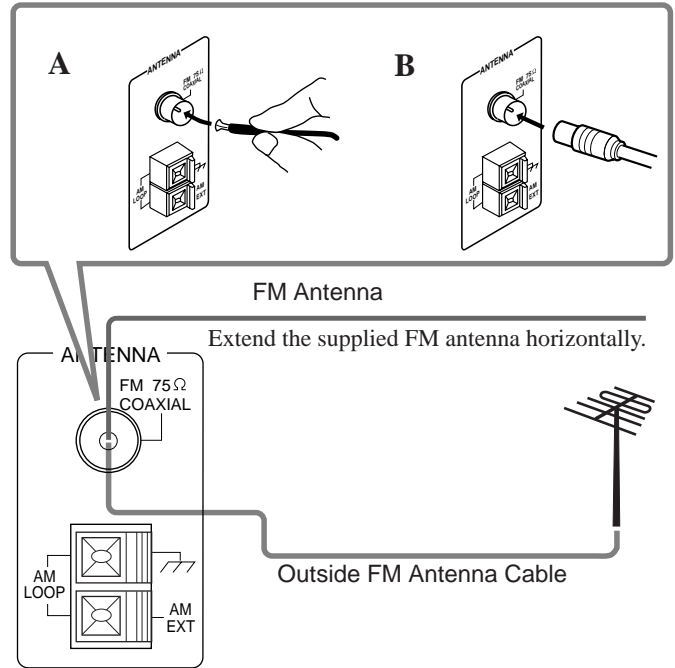

A. Using the Supplied FM Antenna

The FM antenna provided can be connected to the FM 75Ω COAXIAL terminal as temporary measure.

B. Using the Standard Type Connector (Not Supplied)

A standard type connector should be connected to the FM 75Ω COAXIAL terminal.

Note:

If reception is poor, connect the outside antenna.

Before attaching a 75Ω coaxial cable (the kind with a round wire going to an outside antenna), disconnect the supplied FM antenna.

AM Antenna Connections

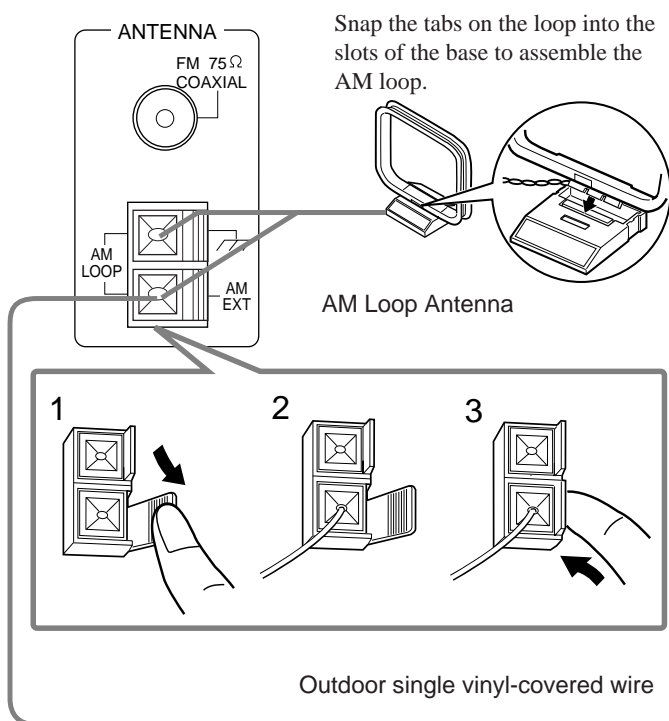

Turn the loop until you have the best reception.

Notes:

- Make sure the antenna conductors do not touch any other terminals, connecting cords and power cord. This could cause poor reception.
- If reception is poor, connect an outdoor single vinyl-covered wire to the AM EXT terminal. (Keep the AM loop antenna connected.)

Connecting the Speakers

You can connect the following speakers:

- Two pairs of front speakers to produce normal stereo sound.
- One pair of rear speakers to enjoy the surround effect.
- One center speaker to produce more effective surround effect (to emphasize human voices).
- One subwoofer to enhance the bass.

IMPORTANT:

After connecting the speakers listed above, set the speaker setting information properly to obtain the best possible DSP (Digital Signal Processor) effect. For details, see page 11.

For each speaker (except for a subwoofer), connect the (-) and (+) terminals on the rear panel to the (-) and (+) terminals marked on the speakers. For connecting a subwoofer, see page 5.

CAUTION:

Use speakers with the SPEAKER IMPEDANCE indicated by the speaker terminals.

Basic connecting procedure

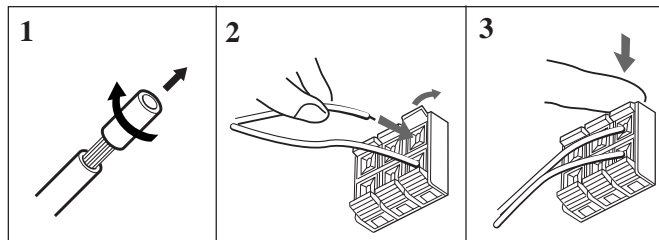

1 Cut, twist and remove the insulation at the end of each speaker signal cable.

2 Open the terminal and then insert the speaker signal cable.

3 Close the terminal.

Connecting the front speakers

You can connect two pairs of front speakers (one pair to the FRONT SPEAKERS ① terminals, and another pair to the FRONT SPEAKERS ② terminals).

Right speaker — FRONT SPEAKERS ① — Left speaker

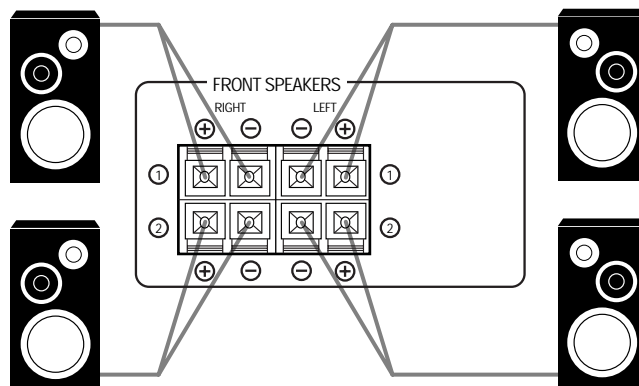

Right speaker — FRONT SPEAKERS ② — Left speaker

Connecting the rear and center speakers

Connect rear speakers to the REAR SPEAKERS terminals and a center speaker to the CENTER SPEAKER terminals.

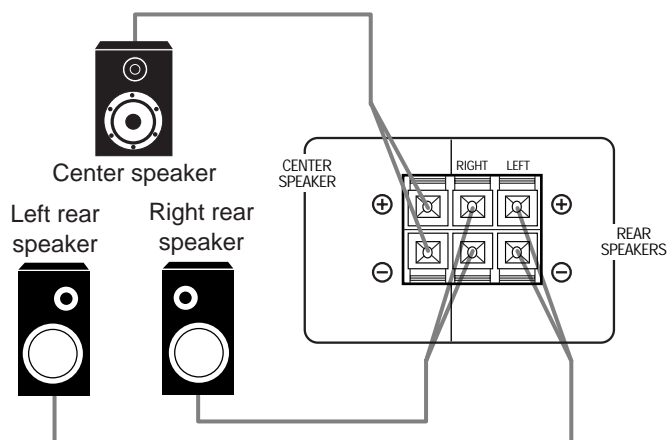

Connecting the subwoofer speaker

You can enhance the bass by connecting a subwoofer. Connect the input jack of a powered subwoofer to the SUBWOOFER OUT jack on the rear panel, using a cable with RCA pin plugs.



Powered subwoofer

Connecting Audio/Video Components

You can connect the following audio/video components to this receiver using cables with RCA pin plugs (not supplied). Refer also to the manuals supplied with your components.

Use the cables with RCA pin plugs (not supplied). Connect the white plug to the audio left jack, and the red plug to the audio right jack.

Audio component connections

CAUTION:

If you connect a sound-enhancing device such as a graphic equalizer between the source components and this receiver, the sound output through this receiver may be distorted.

Turntable

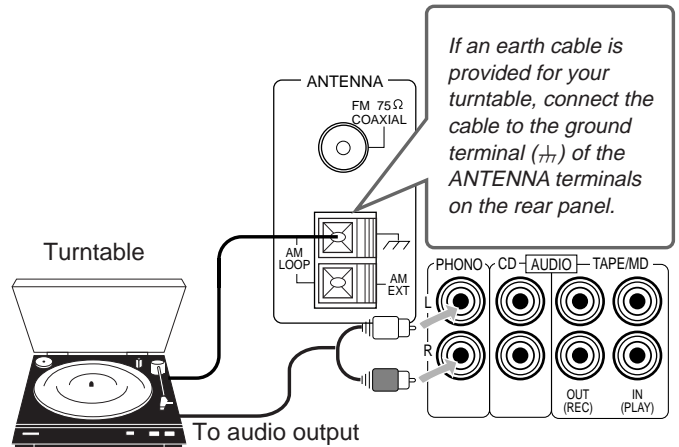

Note:

Any turntables incorporating a small-output cartridge such as an MC (moving-coil type) must be connected to this receiver through a commercial head amplifier or step-up transformer. Direct connection may result in insufficient volume.

CD player

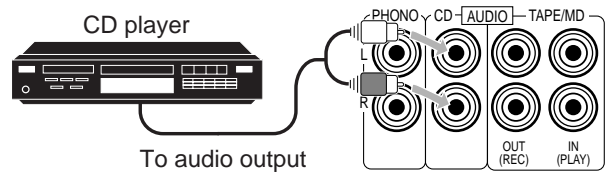

Cassette deck or MD recorder

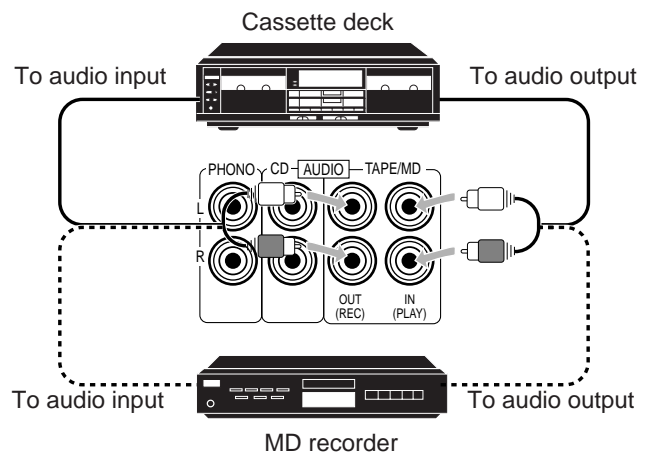

Note:

You can connect either a cassette deck or an MD recorder to the TAPE/MD jacks. When connecting an MD recorder to the TAPE/MD jacks, change the source name, which will be shown on the display when selected as the source, to "M D." See page 11 for details.

If your audio components have a COMPU LINK-3 terminal

See also page 21 for detailed information about the connection and the COMPU LINK-3 remote control system.

Video component connections

Use the cables with RCA pin plugs (not supplied). Connect the white plug to the audio left jack, the red plug to the audio right jack and the yellow plug to the video jack.

TV (as the monitor)

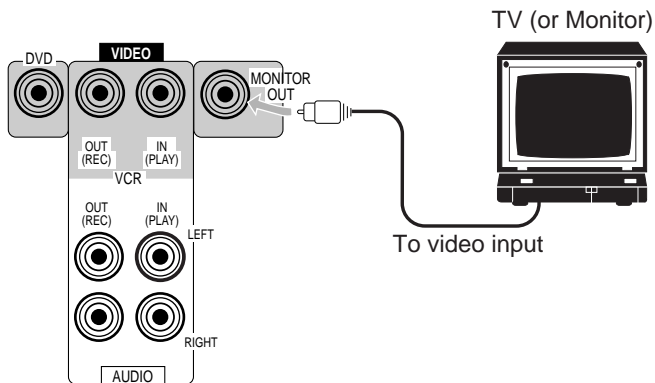

VCR

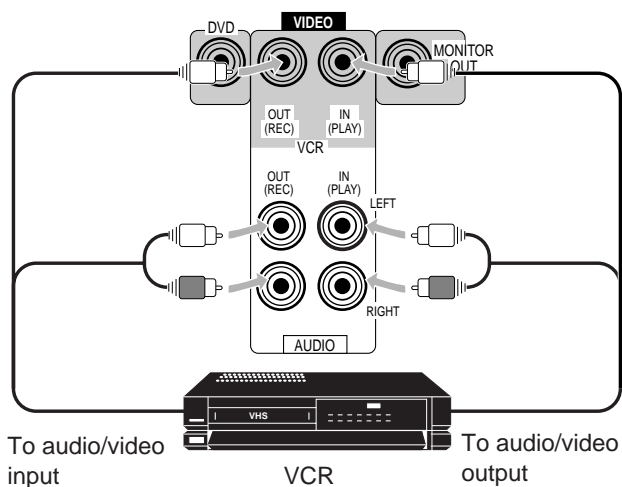

DVD player

- When you connect the DVD player with stereo output jacks:

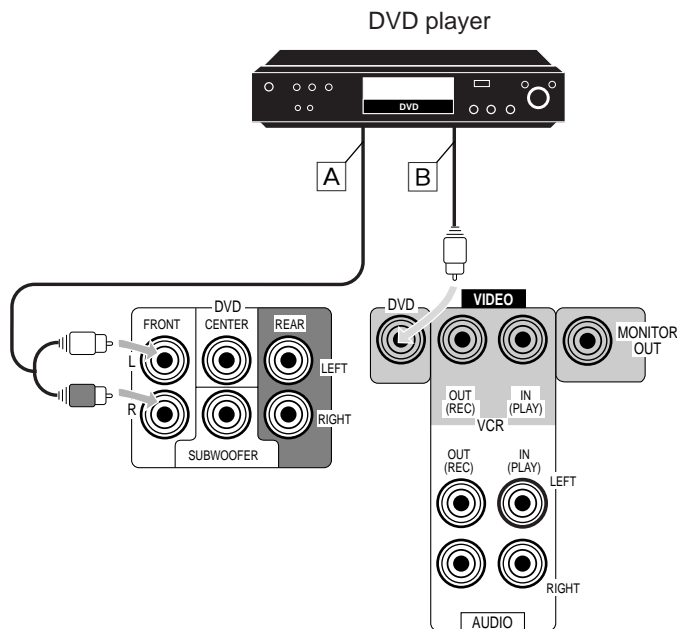

- A To front left/right channel audio output (or to audio mixed output if necessary)
- B To video output

- When you connect the DVD player with its analog discrete output (5.1 CH reproduction) jacks:

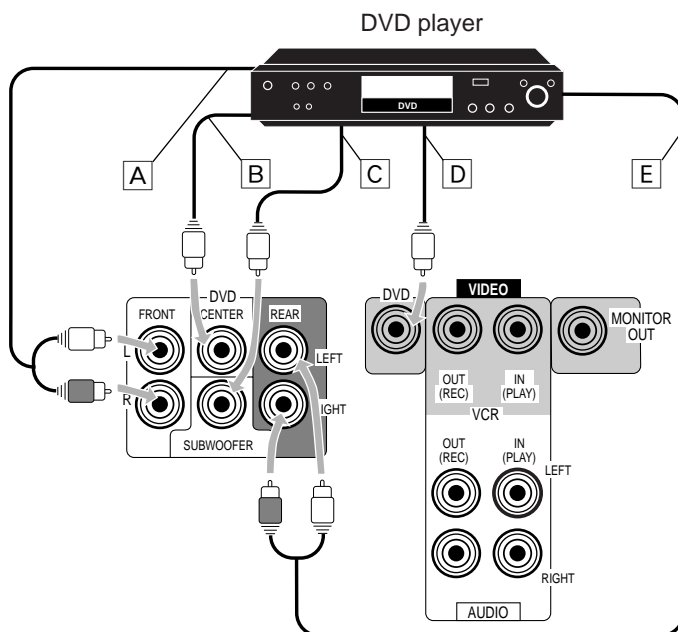

- A To front left/right channel audio output
- B To center channel audio output
- C To subwoofer audio output
- D To video output
- E To rear left/right channel audio output

Connecting the Power Cord

Before plugging the receiver into an AC outlet, make sure that all connections have been made.

Plug the power cord into an AC outlet.

Keep the power cord away from the connecting cables and the antenna. The power cord may cause noise or screen interference. We recommend that you use a coaxial cable to connect the antenna, since it is well-shielded against interference.

Note:

The preset settings such as preset channels and sound adjustment may be erased in a few days in the following cases:

- When you unplug the power cord.
- When a power failure occurs.

CAUTIONS:

- Do not touch the power cord with wet hands.
- Do not pull on the power cord to unplug the cord. When unplugging the cord, always grasp the plug so as not to damage the cord.

Putting Batteries in the Remote Control

Before using the remote control, put two supplied batteries first. When using the remote control, aim the remote control directly at the remote sensor on the receiver.

1. On the back of the remote control, remove the battery cover as illustrated.

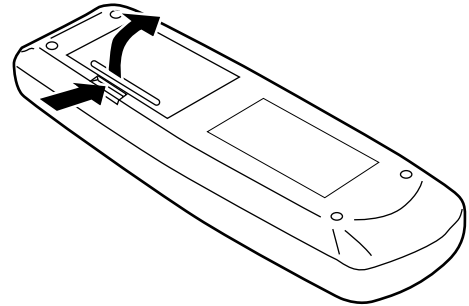

2. Insert batteries. Make sure to observe the proper polarity: (+) to (+) and (-) to (-).

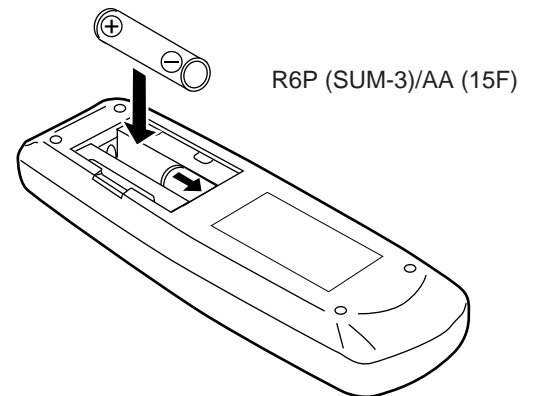

3. Replace the cover.

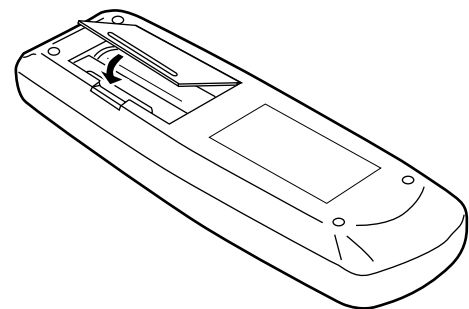

If the range or effectiveness of the remote control decreases, replace the batteries. Use two R6P (SUM-3)/AA (15F) type dry-cell batteries.

CAUTION:

Follow these precautions to avoid leaking or cracking cells:

- Place batteries in the remote control so they match the polarity indicated: (+) to (+) and (-) to (-).
- Use the correct type of batteries. Batteries that look similar may differ in voltage.
- Always replace both batteries at the same time.
- Do not expose batteries to heat or flame.

Basic Operations

The following operations are commonly used when you play any sound source.

Turning the Power On and Off (Standby)

On the front panel:

To turn on the power, press STANDBY/ON . The STANDBY lamp goes off. The name of the current source (or station frequency) appears on the display.

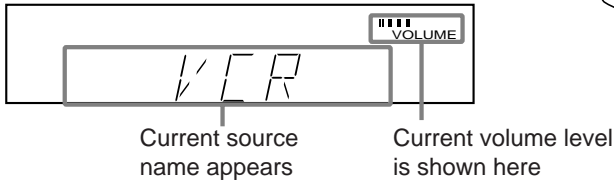
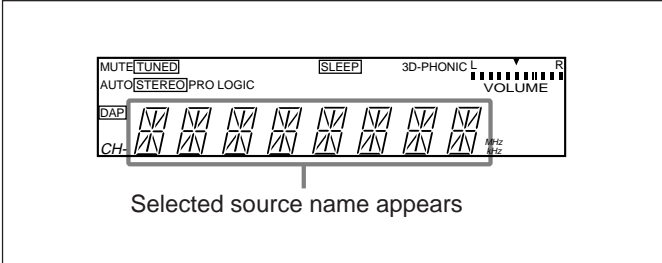
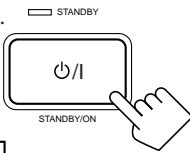

To turn off the power (into standby mode), press STANDBY/ON again. The STANDBY lamp lights up. A small amount of power is consumed in standby mode. To turn the power off completely, unplug the AC power cord.

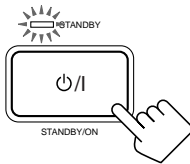

From the remote control:

To turn on the power, press AUDIO . The STANDBY lamp goes off. The name of the current source (or station frequency) appears on the display.

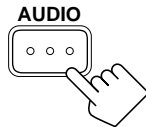

To turn off the power (into standby mode), press AUDIO again. The STANDBY lamp lights up.

On the front panel:

- DVD MULTI Select the DVD player for viewing the digital video disc using the analog discrete output mode (5.1CH reproduction) on the DVD player. To enjoy the DVD MULTI playback, see page 20.
- DVD Select the DVD player for viewing the stereo digital video disc.
- VCR Select the video component connected to the VCR jacks.
- FM Select an FM broadcast.
- AM Select an AM broadcast.
- TAPE/MD Select the cassette deck (or the MD recorder).
- PHONO Select the turntable.
- CD Select the CD player.

From the remote control:

- FM/AM Select an FM or AM broadcast. Each time you press the button, the band changes alternately.
- Other buttons function in the same way as the buttons on the front panel.

Selecting the Source to Play

Press one of the source selecting buttons.

On the front panel:

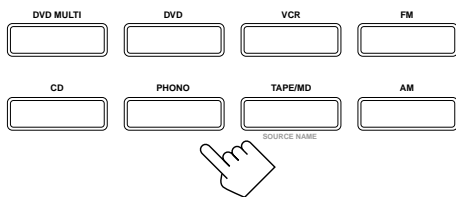

From the remote control:

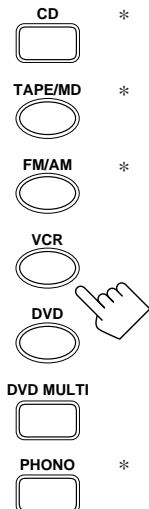

Note:

When you press one of the source selecting buttons, marked above with an asterisk (*), on the remote control, the receiver automatically turns on.

Note:

When connecting an MD recorder (to the TAPE/MD jacks), change the source name that appears on the display. See page 11 for details.

Selecting different sources for picture and sound

You can watch picture from a video component while listening to sound from another component.

Press one of the audio source selecting buttons (CD, TAPE/MD, PHONO, FM, AM), while viewing the picture from a video component such as the VCR or DVD player, etc.

Note:

Once you have selected a video source, pictures of the selected source are sent to the TV until you select another video source.

Adjusting the Volume

On the front panel:

To increase the volume, turn MASTER VOLUME clockwise (+).

To decrease the volume, turn it counterclockwise (-).

- When you turn MASTER VOLUME rapidly, the volume level also changes rapidly.
- When you turn MASTER VOLUME slowly, the volume level also changes slowly.

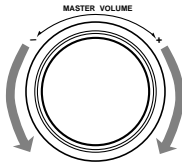

From the remote control:

To increase the volume, press VOLUME +.

To decrease the volume, press VOLUME -.

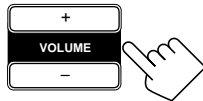

CAUTION:

Always set the volume to the minimum before starting any source. If the volume is set at its high level, the sudden blast of sound energy can permanently damage your hearing and/or ruin your speakers.

Note:

The volume level can be adjusted within the range of "0" (minimum) to "80" (maximum).

Selecting the Front Speakers

On the front panel ONLY:

When you have connected two pairs of the front speakers, you can select which to use. Pressing SPEAKERS 1 or SPEAKERS 2 activates the respective set of speakers.

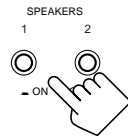

- To use the speakers connected to the **FRONT SPEAKERS ① terminals**, press SPEAKERS 1 to set it in the **ON** position, and press SPEAKERS 2 to set it in the **OFF** position.
- To use the speakers connected to the **FRONT SPEAKERS ② terminals**, press SPEAKERS 2 to set it in the **ON** position, and press SPEAKERS 1 to set it in the **OFF** position.
- To use **both sets of the speakers**, press SPEAKERS 1 to set it in the **ON** position, and press SPEAKERS 2 to set it in the **ON** position.
- To use **neither set of the speakers**, press SPEAKERS 1 and SPEAKERS 2 to set them in the **OFF** position.

Note:

When only one set of the speakers is connected to either the **FRONT SPEAKERS ①** or **② terminals**, do not activate both pairs of the speakers. If you do, no sound comes out of the front speakers.

Listening only with headphones

1. Connect a pair of headphones to the PHONES jack on the front panel.
2. Press SPEAKERS 1 and SPEAKERS 2 to set them in the **OFF** position.

CAUTION:

Be sure to turn down the volume before connecting or putting on headphones, as high volume can damage both the headphones and your hearing.

Note:

You cannot shut off the sound through the other speakers using the **SPEAKERS 1** and **2** buttons.

Muting the Sound

From the remote control ONLY:

Press **MUTING** to mute the sound through all speakers and headphones connected.

"MUTING" appears on the display and the volume turns off (the volume level indicator goes off).

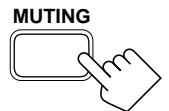

To restore the sound, press **MUTING** again.

- Turning **MASTER VOLUME** or pressing **VOLUME +/-** also restores the sound.

Recording a Source

You can record any source playing through the receiver to a cassette deck (or an MD recorder) connected to the **TAPE/MD** jacks and the **VCR** connected to the **VCR** jacks at the same time.

While recording, you can listen to the selected sound source at whatever sound level you like, without affecting the sound levels of the recording.

Note:

The output volume level, tone adjustment (see page 10), Bass Boost (see page 10) and DSP modes (see page 15) cannot affect the recording.

IMPORTANT:

Before recording, turn off the **DVD MULTI** playback mode.

Attenuating the Input Signal

When the input level of the playing source is too high, the sounds will be distorted. If this happens, you need to attenuate the input signal level to prevent the sound distortion.

On the front panel ONLY:

Press INPUT ATT. so that the lamp next to the button lights up.

- Each time you press the button, the Input Attenuator mode turns on or off.

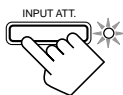

Note:

When selecting "DVDMULTI" as the source, this effect only applies to front left and right channel signals.

Adjusting the Front Speaker Output Balance

If the sounds you hear from the front right and left speakers are unequal, you can adjust the speaker output balance.

Before you start, remember...

- There is a time limit in doing the following steps. If the setting is canceled before you finish, start from step 1 again.

On the front panel ONLY:

1. Press ADJUST so that MULTI CURSOR Δ / ∇ buttons work for adjusting the sound.

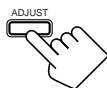

2. Press MULTI CURSOR Δ / ∇ repeatedly until "BALANCE" appears on the display.

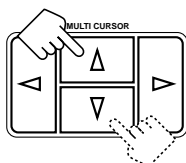

3. Press MULTI CURSOR \triangleleft / \triangleright to adjust the balance.

- Pressing \triangleleft decreases the right channel output.
- Pressing \triangleright decreases the left channel output.

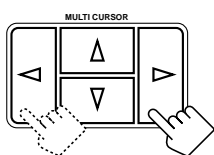

Reinforcing the Bass

With this Bass Boost function, you can boost the bass level.

Before you start, remember...

- There is a time limit in doing the following steps. If the setting is canceled before you finish, start from step 1 again.

On the front panel ONLY:

1. Press ADJUST so that MULTI CURSOR Δ / ∇ buttons work for adjusting the sound.



2. Press MULTI CURSOR Δ / ∇ repeatedly until "B-BOOST" appears on the display.

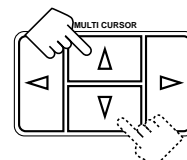

3. Press MULTI CURSOR \triangleleft / \triangleright to switch this function "ON" or "OFF."

- When this function is switched "ON," the BASS BOOST lamp on the front panel lights up.

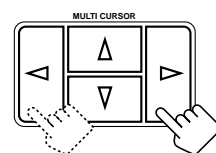

Note:

The Bass Boost function affects the front speaker sounds only.

Adjusting the Tone

You can adjust the treble and bass sounds as you like.

Before you start, remember...

- There is a time limit in doing the following steps. If the setting is canceled before you finish, start from step 1 again.

On the front panel ONLY:

1. Press ADJUST so that MULTI CURSOR Δ / ∇ buttons work for adjusting the sound.

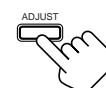

2. Press MULTI CURSOR Δ / ∇ repeatedly until "- BASS +" or "-TREBLE+" appears on the display.

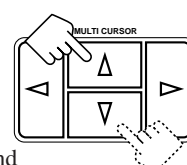

- Select "- BASS +" to adjust the bass sound level.
- Select "-TREBLE+" to adjust the treble sound level.

3. Press MULTI CURSOR \triangleleft / \triangleright to adjust the bass or treble sound level within the range of -10 to +10.

- Each time you press the button, the sound level changes by ± 2 .

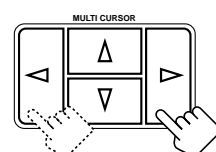

Basic Settings

Some of the following settings are required after connecting and positioning your speakers in your listening room, while others will make operations easier.

Changing the Source Name

When you have connected an MD recorder to the TAPE/MD jacks on the rear panel: Change the source name shown on the display when you select the MD recorder as the source.

On the front panel ONLY:

When changing the source name from "TAPE" to "M D":

1. Press TAPE/MD.

- Make sure "TAPE" appears on the display.

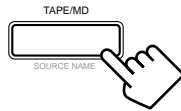

2. Press and hold SOURCE NAME (the same button as TAPE/MD) until "M D" appears on the display.

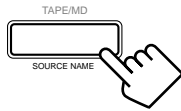

To change the source name from "M D" to "TAPE," repeat the same procedure above (in step 1, make sure "M D" appears on the display).

Note:

Without changing the source name, you can still use the connected components. However, there may be some inconvenience.

- "TAPE" will appear on the display when you select the MD recorder.
- You cannot use the COMPU LINK remote control system (see page 21) to operate the MD recorder.

Setting Center and Rear Speakers for the DSP Modes

To obtain the best possible surround sound of the DSP (Digital Signal Processor) modes (see page 15), you have to register the information about the speaker arrangement after all connections are completed.

Center Speaker Setting

Register the center speaker size.

Before you start, remember...

- There is a time limit in doing the following steps. If the setting is canceled before you finish, start from step 1 again.

On the front panel ONLY:

1. Press SETTING so that MULTI CURSOR Δ / ∇ buttons work for setting the center speaker size.

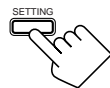

2. Press MULTI CURSOR Δ / ∇ repeatedly until "CNTR SPK" (Center Speaker) appears on the display.

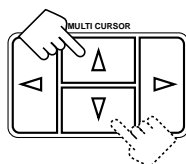

3. Press MULTI CURSOR $\triangleleft / \triangleright$ to select your center speaker size.

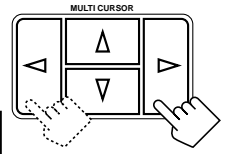
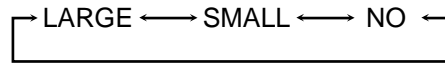

LARGE: Select this mode when the size of the center speaker is the same as that of the front speakers.

SMALL: Select this mode when the size of the center speaker is smaller than that of the front speakers.

NO: Select this mode when you do not use a center speaker.

Rear Speaker Setting

Register whether you have connected the rear speakers or not.

Before you start, remember...

- There is a time limit in doing the following steps. If the setting is canceled before you finish, start from step 1 again.

On the front panel ONLY:

1. Press SETTING so that MULTI CURSOR Δ / ∇ buttons work for setting the rear speaker information.

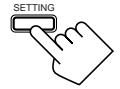

2. Press MULTI CURSOR Δ / ∇ repeatedly until "REAR SPK" (Rear Speaker) appears on the display.

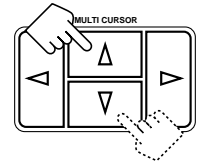

3. Press MULTI CURSOR $\triangleleft / \triangleright$ to register whether you have connected the rear speakers.

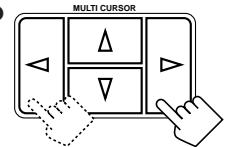

YES: Select this mode when you use rear speakers.

NO: Select this mode when you do not use rear speakers.

Note:

When you change your speakers, you need to register the information about the speakers again.

Delay Time Setting

Register the delay time of the sound from the rear speakers, comparing the sound from the front speakers.

Before you start, remember...

- There is a time limit in doing the following steps. If the setting is canceled before you finish, start from step 1 again.
- You can adjust the delay time only when you have connected the rear speakers and have set "REAR SPK" to "YES" (see above).
- Delay time setting is only valid for "PROLOGIC" (see page 15).

On the front panel:

1. Press **SETTING** so that **MULTI CURSOR** Δ / ∇ buttons work for setting the delay time.

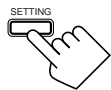

2. Press **MULTI CURSOR** Δ / ∇ repeatedly until “-DELAY +” appears on the display.

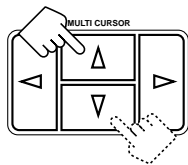

3. Press **MULTI CURSOR** $\triangleleft / \triangleright$ to select an appropriate delay time.

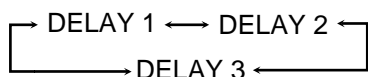
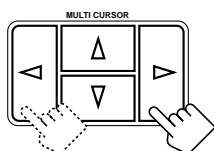

DELAY 1: Select this mode when the distance from you to your rear speakers is greater than that to the front speakers.

DELAY 2: Select this mode when the distance from you to your rear speakers is almost equal to that to the front speakers.

DELAY 3: Select this mode when the distance from you to your rear speakers is less than that to the front speakers.

From the remote control:

1. Press **SOUND CONTROL**.
2. Press **SURROUND** repeatedly until “PROLOGIC” appears on the display.
3. Press **DELAY** repeatedly until an appropriate delay time appears on the display.

Storing the Basic Settings and Adjustments — One Touch Operation

JVC's One Touch Operation function is used to assign and store different sound settings for each different playing source. By using this function, you do not have to change the settings every time you change the source. The stored settings for the newly selected source are automatically recalled.

The following can be stored for each source:

- Volume level (see page 9)
- Input Attenuator (see page 10)
- Balance (see page 10)
- Bass Boost (see page 10)
- Tone adjustment (see page 10)
- DSP modes
 - 3D-PHONIC mode settings (see page 17)
 - DAP mode settings (see page 17)
 - Surround mode settings (see page 18)
- DVD MULTI playback mode settings (see page 20)

To store the sound settings

1. Press **ONE TOUCH OPERATION**.

The **ONE TOUCH OPERATION** lamp lights up, then the previously memorized settings are recalled.



On the front panel



On the remote

2. **Adjust the sound using the functions listed to the left.**

The newly adjusted settings are memorized.

To recall the sound settings

With the **ONE TOUCH OPERATION** lamp lit, the settings for the currently selected source are recalled, when the source is selected.

To cancel the One Touch Operation function

Press **ONE TOUCH OPERATION** so that the lamp goes off. (Even though the One Touch Operation function is canceled, the recalled sound effects remain active.)

Notes:

- If the source is FM or AM, you can assign a different setting for each band.
- The DSP modes and DVD MULTI playback mode cannot be used at the same time.

Using the Sleep Timer

Using the Sleep Timer, you can fall asleep to music and know the receiver will turn off by itself rather than play all night.

From the remote control ONLY:

Press **SLEEP** repeatedly.

The **SLEEP** indicator lights up on the display, and the shut-off time changes as follows (in minutes):

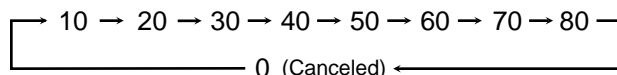
**When the shut-off time comes**

The receiver turns off automatically.

To check or change the time remaining until the shut-off time

Press **SLEEP** once.

The remaining time until the shut-off time appears in minutes.

- To change the shut-off time, press **SLEEP** repeatedly.

To cancel the Sleep Timer

Press **SLEEP** repeatedly until “0” appears on the display. (The **SLEEP** indicator goes off.)

Turning off the power also cancels the Sleep Timer.

Receiving Radio Broadcasts

You can browse through all the stations or use the preset function to go immediately to a particular station.

Setting the AM Tuner Interval Spacing

Some countries space AM stations 9 kHz apart, and other countries use 10 kHz spacing. When shipped, the spacing is set to 9 kHz.

On the front panel ONLY:

To select the 10 kHz interval:

Be sure the receiver is tuned off, but is plugged into an AC outlet. Hold down MULTI CURSOR Δ and press STANDBY/ON O/I . Now the 10 kHz interval is selected.



To change back to the 9 kHz interval:

Be sure the receiver is tuned off, but plugged into an AC outlet. Hold down MULTI CURSOR ∇ and press STANDBY/ON O/I . Now the 9 kHz interval is selected.

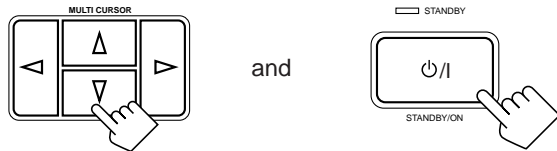

Tuning in Stations Manually

On the front panel ONLY:

1. Press FM or AM.

The last station of the selected band is tuned in.

- MULTI CURSOR Δ / ∇ / \triangleleft / \triangleright buttons can be now used for operating the tuner.

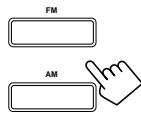

2. Press MULTI CURSOR Δ / ∇ repeatedly until “-TUNING+” appears on the display.

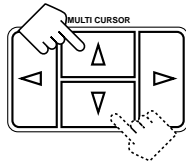

-- TUNING +

3. Press MULTI CURSOR \triangleleft / \triangleright until you find the frequency you want.

- Pressing \triangleleft decreases the frequency.
- Pressing \triangleright increases the frequency.

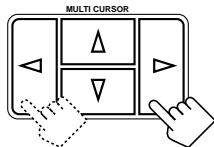

Notes:

- When you hold MULTI CURSOR \triangleleft / \triangleright in step 3, the frequency keeps changing until a station is tuned in.
- When a station of sufficient signal strength is tuned in, the TUNED indicator lights up on the display. When an FM stereo program is received, the STEREO indicator also lights up.

Using Preset Tuning

Once a station is assigned to a channel number, the station can be quickly tuned. You can preset up to 30 FM stations and 15 AM stations.

To store the preset stations

Before you start, remember...

- There is a time limit in doing the following steps. If the setting is canceled before you finish, start from step 1 again.

On the front panel ONLY:

1. Tune in the station you want to preset (see “Tuning in Stations Manually”).

If you want to store the FM reception mode for this station, select the FM reception mode you want. See “Selecting the FM Reception Mode”.

2. Press MEMORY.

“CH-” appears and the channel number position starts flashing on the display for about 5 seconds.



CH- _ _

3. Press MULTI CURSOR \triangleleft / \triangleright to select a channel number while the channel number position is flashing.

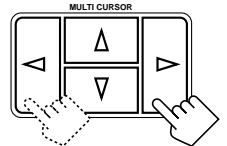

Note:

You can use the 10 keys on the remote control to select the preset number. When using the 10 keys, be sure that they are activated for the tuner, not for the CD and others. (See page 22.)

4. Press MEMORY again while the selected channel number is flashing on the display.

The selected channel number stops flashing. The station is assigned to the selected channel number.

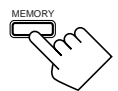

5. Repeat steps 1 to 4 until you store all the stations you want.

To erase a stored preset station

Storing a new station on a used number erases the previously stored one.

To tune in a preset station

On the front panel:

1. Press FM or AM.

The last station of the selected band is tuned in.

- MULTI CURSOR Δ / ∇ / \triangleleft / \triangleright buttons can be now used for operating the tuner.

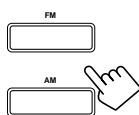

2. Press MULTI CURSOR Δ / ∇ repeatedly until “-PRESET+” appears on the display.

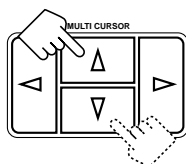

3. Press MULTI CURSOR \triangleleft / \triangleright to select a preset channel station.

- Pressing \triangleleft decreases the preset channel number.
- Pressing \triangleright increases the preset channel number.

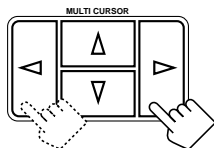

From the remote control:

1. Press FM/AM.

The last station is tuned in.

- Each time you press the button, the band alternates between FM and AM.

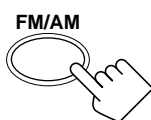

2. Press the 10 keys to select a preset channel number.

- For channel number 5, press 5.
- For channel number 15, press +10 then 5.
- For channel number 20, press +10 then 10.
- For channel number 30, press +10, +10, then 10.

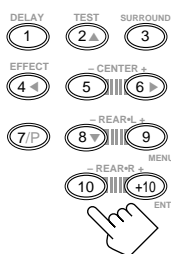

Note:

When you use the 10 keys on the remote control, be sure that they are activated for the tuner, not for the CD and others. (See page 22.)

Selecting the FM Reception Mode

When an FM stereo broadcast is hard to receive or noisy

You can change the FM reception mode while receiving an FM broadcast.

On the front panel ONLY:

1. Press FM.

The last station of the selected band is tuned in.

- MULTI CURSOR Δ / ∇ / \triangleleft / \triangleright buttons can be now used for operating the tuner.

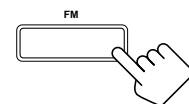

2. Press MULTI CURSOR Δ / ∇ repeatedly until “FM MODE” appears on the display.

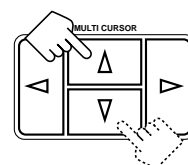

FM MODE

3. Press MULTI CURSOR \triangleleft / \triangleright to switch the FM reception “FM MONO” or “FM AUTO.”

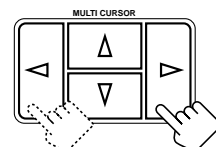

FM MONO



FM AUTO

FM MONO: Reception will be improved although you will lose the stereo effect. In this mode, you will hear noise while tuning into the stations. The MUTE AUTO indicator goes off on the display.

FM AUTO: When a program is broadcasted in stereo, you will hear stereo sound; when in monaural, you will hear monaural sounds. This mode is also useful to suppress static noise between stations. The MUTE AUTO indicator lights up on the display.

Using the DSP Modes

The built-in Surround Processor provides three types of the DSP (Digital Signal Processor) mode — 3D-PHONIC mode, DAP (Digital Acoustic Processor) mode and Surround mode (Dolby Pro Logic and JVC Theater Surround).

3D-PHONIC modes

The 3D-PHONIC mode gives you such a nearly surround effect as it is reproduced through the Dolby Surround decoder, which is widely used to reproduce sounds with a feeling of movement like those experienced in movie theaters. The 3D-PHONIC mode is the result of research on sound localization technology carried out at JVC for many years. **This mode can be used when two front speakers are connected to this receiver (without respect to the rear/center speaker connection).**

You can select either 3D ACTION or 3D THEATER to your preference.

3D ACTION: Best for action and war movies — where the action is fast and explosive.

3D THEATER: Reproduces the sound field of a large theater.

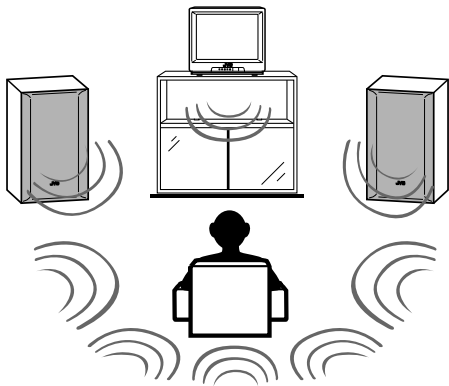

DAP modes

The sound heard in a concert hall or club consists of direct sound and indirect sound — early reflections and reflections from behind. Direct sounds reach the listener directly without any reflection. On the other hand, indirect sounds are delayed by the distances of the ceiling and walls. These direct sounds and indirect sounds are the most important elements of the acoustic surround effects. The DAP mode can create these important elements, and gives you a real “being there” feeling. **This mode can be used when the front speakers are connected to this receiver (without respect to the rear/center speaker connection).**

You can select one of the following to your preference.

DANCE CLUB: Gives a throbbing bass beat.

LIVE CLUB: Gives the feeling of a live music club with a low ceiling.

HALL: Gives clear vocal and the feeling of a concert hall.

PAVILION: Gives the spacious feeling of a pavilion with a high ceiling.

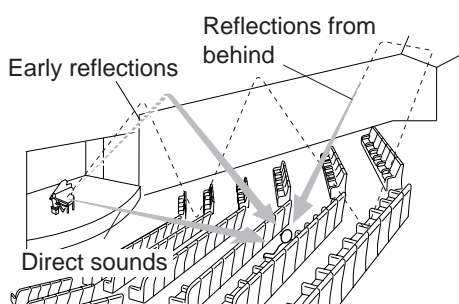

Surround Modes

With this receiver, you can use two types of the Surround modes.

• Dolby Surround

Dolby Surround has been developed to reproduce the important elements of the acoustic surround at home.

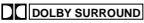
To watch the soundtracks of video software bearing the mark  * which includes the same encoded surround information as found in Dolby Stereo films, the receiver can provide you with Dolby Surround decoder.

There are two types of Dolby Surround – “Pro Logic” and “3 Stereo.”

“Pro Logic” can be used when the front speakers and rear speakers are connected to this receiver (regardless of the center speaker connection). On the other hand, “3 Stereo” can be used when the rear speakers are not connected (center speaker must be connected).

• JVC Theater Surround

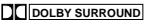
In order to reproduce a more realistic sound field in your listening room while playing soundtracks of video software bearing the mark  , JVC Theater Surround has been designed to give you clearer vocals and to create a real “being there” feeling.

This mode can be used when the front speakers and rear speakers are connected to this receiver (without respect to the center speaker connection).

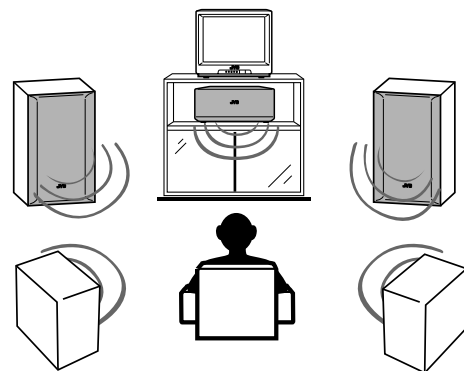

Notes:

- The DSP modes have no effect on monaural sources.
- The DSP modes cannot be used for recording.
- When you select “DVMULTI” as the source to play, you cannot select or adjust the DSP modes.

IMPORTANT:

Before recording, turn off the DVD MULTI playback mode.

As for the DVD MULTI playback mode, see page 20.

* Manufactured under license from Dolby Laboratories Licensing Corporation. “Dolby,” the double-D symbol, and “Pro Logic” are trademarks of Dolby Laboratories Licensing Corporation.

Available DSP Modes According to the Speaker Arrangement

Available DSP modes will vary depending on how many speakers are used with this receiver.

Make sure that you have set the speaker information correctly (see page 11).

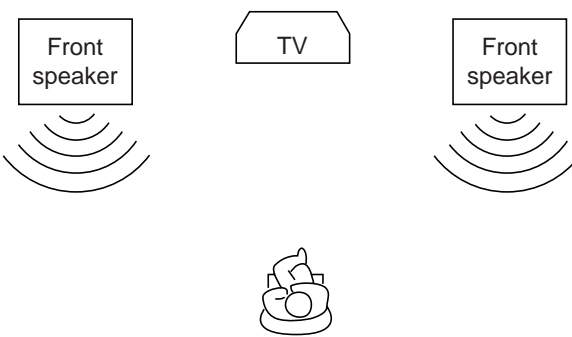
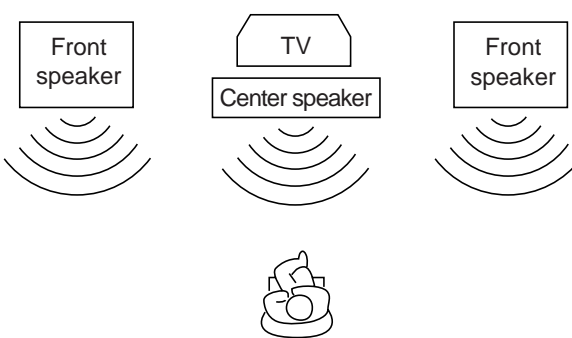
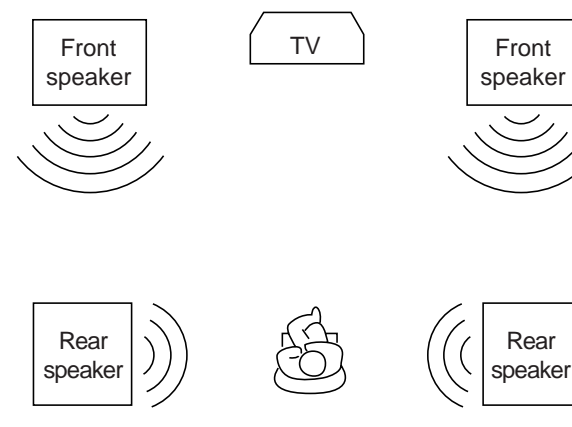
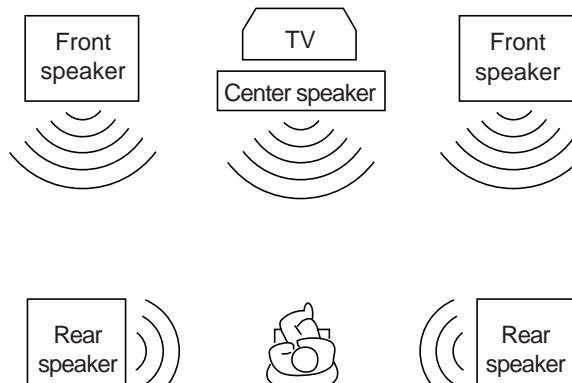
Speaker arrangements	Available DSP modes
 <p>Diagram showing two front speakers, a TV, and a subwoofer.</p>	<p>Each time you press SURROUND, the DSP modes change as follows:</p> <ul style="list-style-type: none"> • 3D THEATER • DANCE C (DANCE CLUB) • LIVE C (LIVE CLUB) • HALL • PAVILION • 3D ACTION • OFF (DSP mode is canceled)
 <p>Diagram showing two front speakers, a TV, and a center speaker.</p>	<p>Each time you press SURROUND, the DSP modes change as follows:</p> <ul style="list-style-type: none"> • 3 STEREO • 3D THEATER • DANCE C (DANCE CLUB) • LIVE C (LIVE CLUB) • HALL • PAVILION • 3D ACTION • OFF (DSP mode is canceled)
 <p>Diagram showing two front speakers, a TV, and two rear speakers.</p>	<p>Each time you press SURROUND, the DSP modes change as follows:</p> <ul style="list-style-type: none"> • PRO LOGIC • THEATER • DANCE C (DANCE CLUB) • LIVE C (LIVE CLUB) • HALL • PAVILION • 3D ACTION • OFF (DSP mode is canceled)
 <p>Diagram showing two front speakers, a TV, a center speaker, and two rear speakers.</p>	<p>Each time you press SURROUND, the DSP modes change as follows:</p> <ul style="list-style-type: none"> • PRO LOGIC • THEATER • DANCE C (DANCE CLUB) • LIVE C (LIVE CLUB) • HALL • PAVILION • 3D ACTION • OFF (DSP mode is canceled)

Adjusting the 3D-PHONIC Modes

Before you start, remember...

- Make sure that you have set the speaker information correctly (see page 11).
- There is a time limit in doing the following steps. If the setting is canceled before you finish, start from step 1 again.

On the front panel:

1. Press **SURROUND** repeatedly until “3DACTION” or “3DTHEATR” appears on the display.

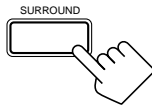

The 3D-PHONIC and PRO LOGIC indicators also light up on the display.

2. Press **ADJUST** so that **MULTI CURSOR** $\Delta / \nabla / \triangleleft / \triangleright$ buttons work for adjusting the surround setting.



3. Press **MULTI CURSOR** Δ / ∇ repeatedly until “-EFFECT+” appears on the display.

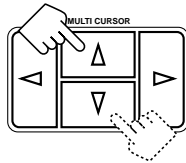

4. Press **MULTI CURSOR** $\triangleleft / \triangleright$ to select an effect level you want.

- Each time you press the button, the effect level changes as follows:

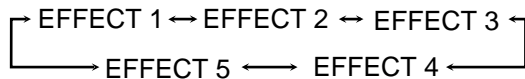

As the number increases, the selected 3D-PHONIC mode becomes stronger.

From the remote control:

1. Press **SOUND CONTROL**.

The 10 keys are activated for sound adjustments.



2. Press **SURROUND** repeatedly until “3DACTION” or “3DTHEATR” appears on the display.



The 3D-PHONIC and PRO LOGIC indicators also light up on the display.

3. Press **EFFECT** to select an effect level you want.

- Each time you press the button, the effect level changes as follows:

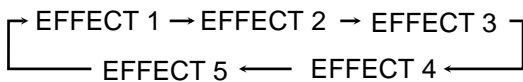

As the number increases, the selected 3D-PHONIC mode becomes stronger.

Adjusting the DAP Modes

Before you start, remember...

- Make sure that you have set the speaker information correctly (see page 11).
- There is a time limit in doing the following steps. If the setting is canceled before you finish, start from step 1 again.
- You can only adjust the rear speaker output level when you have connected the rear speakers and have set “REAR SPK” to “YES” (see page 11).

On the front panel:

1. Press **SURROUND** repeatedly until the DAP mode — **DANCE CLUB, LIVE CLUB, HALL, or PAVILION** — appears on the display.

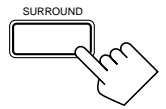

The DAP indicator also lights up on the display.

2. Press **ADJUST** so that **MULTI CURSOR** $\Delta / \nabla / \triangleleft / \triangleright$ buttons work for adjusting the DSP setting.

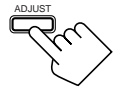

3. Press **MULTI CURSOR** Δ / ∇ repeatedly until “- REAR +” appears on the display.

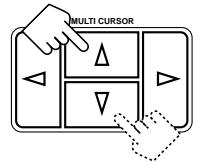

4. Press **MULTI CURSOR** $\triangleleft / \triangleright$ to adjust the rear speaker output level (from -10 to +10).

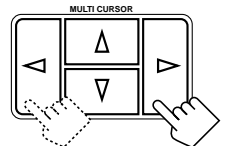

Note:

You cannot adjust the left and right rear speaker output levels separately.

5. Press **MULTI CURSOR** Δ / ∇ repeatedly until “-EFFECT+” appears on the display.

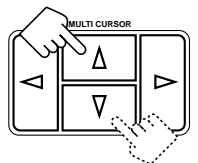

6. Press **MULTI CURSOR** $\triangleleft / \triangleright$ to select an effect level you want.

- Each time you press the button, the effect level changes as follows:

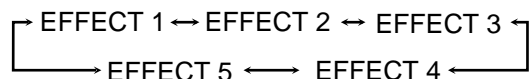
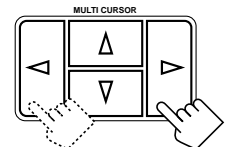

As the number increases, the selected DAP mode becomes stronger.

From the remote control:**1. Press SOUND CONTROL.**

The 10 keys are activated for sound adjustments.

**2. Press SURROUND repeatedly until the DAP mode — DANCE CLUB, LIVE CLUB, HALL, or PAVILION — appears on the display.**

The DAP indicator also lights up on the display.

**3. Press REAR•L - / + to adjust the rear speaker output level.**

- Pressing REAR•L - decreases the output level up to -10 dB.
- Pressing REAR•L + increases the output level up to +10 dB.

**Note:**

You cannot adjust the left and right rear speaker output levels separately.

4. Press EFFECT to select an effect level you want.

- Each time you press the button, the effect level changes as follows:

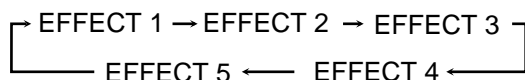

As the number increases, the selected DAP mode becomes stronger.



Adjusting the Surround Modes — Dolby Surround and JVC Theater Surround

Before you start, remember...

- Make sure that you have set the speaker information correctly (see page 11).
- There is a time limit in doing the following steps. If the setting is canceled before you finish, start from step 1 again.
- You can only adjust the effect level when selecting JVC Theater Surround.
- You can only adjust the rear and/or center speaker output levels when you have connected rear speakers and/or a center speaker and have set "REAR SPK" and/or "CNTR SPK" correctly. See page 11.

From the remote control:**1. Press SOUND CONTROL.**

The 10 keys are activated for sound adjustments.

**2. Press SURROUND repeatedly until the mode — "PROLOGIC," "3 STEREO," or "THEATER" — appears on the display.**

- For "PROLOGIC" and "3 STEREO," the PRO LOGIC indicator lights up on the display.
- For "THEATER," the PRO LOGIC and DAP indicators light up on the display.

**3. Press TEST to check the speaker output balance.**

"TEST" starts flashing on the display, and a test tone comes out of the speakers in the following order:

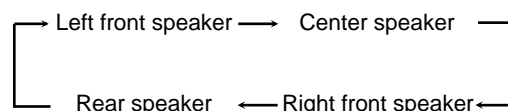
**Note:**

You can adjust the speaker output levels without outputting the test tone.

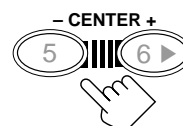
**4. Press CENTER - / + repeatedly to adjust the center speaker output level (from -10 to +10).****5. Press REAR•L - / + to adjust the rear speaker output level (from -10 to +10).****Notes:**

- You cannot adjust the left and right rear speaker output levels separately.
- You cannot use the REAR•R - / + buttons to adjust the rear speaker output level.

6. Press TEST again to stop the test tone.**7. ONLY FOR JVC Theater Surround:****Press EFFECT to select an effect level you want.**

- Each time you press the button, the effect level changes as follows:

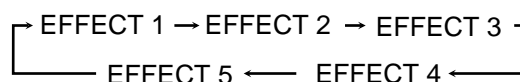

As the number increases, JVC Theater Surround becomes stronger.



On the front panel:

You can also use the buttons on the front panel to adjust the Surround modes. However, no test tone is available when using the buttons on the front panel. So, make adjustments while listening to the sound of the source played back.

1. Press **SURROUND** repeatedly until the mode — “PROLOGIC,” “3 STEREO,” or “THEATER”— appears on the display.

The PRO LOGIC indicator lights up on the display.

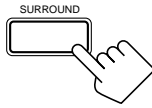

2. Press **ADJUST** so that **MULTI CURSOR** $\Delta / \nabla / \triangleleft / \triangleright$ buttons work for adjusting the DSP setting.

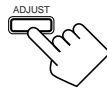

3. Press **MULTI CURSOR** Δ / ∇ repeatedly until “-CENTER+” appears on the display.

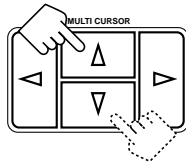

4. Press **MULTI CURSOR** $\triangleleft / \triangleright$ to adjust the center speaker output level (from -10 to +10).

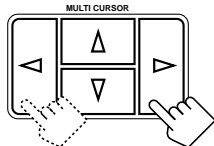

5. Press **MULTI CURSOR** Δ / ∇ repeatedly until “- REAR +” appears on the display.

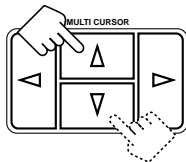

6. Press **MULTI CURSOR** $\triangleleft / \triangleright$ to adjust the rear speaker output level (from -10 to +10).

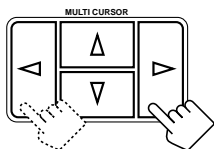
**Note:**

You cannot adjust the left and right rear speaker output levels separately.

7. **ONLY FOR JVC Theater Surround:**

Press **MULTI CURSOR** Δ / ∇ repeatedly until “-EFFECT+” appears on the display.

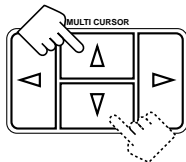

8. **ONLY FOR JVC Theater Surround:**

Press **MULTI CURSOR** $\triangleleft / \triangleright$ to select an effect level you want.

- Each time you press the button, the effect level changes as follows:

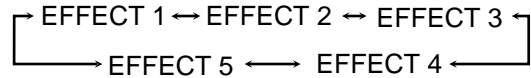
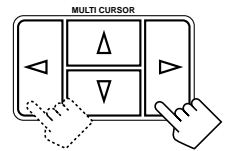

As the number increases, JVC Theater Surround becomes stronger.

Activating the DSP Modes

Once you have finished adjustments for the DSP modes, you can use the same adjustments every time you want to use these modes.

On the front panel:

1. Press **SURROUND** repeatedly until the DSP mode you want appears on the display.

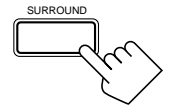

- Each time you press the button, the DSP modes change. (See page 16 for more details.)

2. **Select and play a sound source.**

- To enjoy the 3D-PHONIC, Dolby Surround, and JVC Theater Surround, play back a software which was processed with Dolby Surround and is labeled with mark.

To cancel the DSP mode

Press **SURROUND** repeatedly until “OFF” appears on the display.

From the remote control:

1. Press **SOUND CONTROL**.

The 10 keys are activated for sound adjustments.



2. Press **SURROUND** repeatedly until the DSP mode you want appears on the display.

- Each time you press the button, the DSP modes change. (See page 16 for more details.)



3. **Select and play a sound source.**

- To enjoy the 3D-PHONIC, Dolby Surround, and JVC Theater Surround, play back a software which was processed with Dolby Surround and is labeled with mark.

To cancel the DSP mode

Press **SURROUND** repeatedly until “OFF” appears on the display in step 2 above.

Using the DVD MULTI Playback Mode

This receiver provides the DVD MULTI playback mode for reproducing the analog discrete output mode of the DVD player. Before playing back a DVD, refer also to the manual supplied with the DVD player.

Activating the DVD MULTI Playback Mode

You can adjust the DVD MULTI playback mode while playing back a DVD using the analog discrete output mode on the DVD player. Once you made adjustments, the receiver memorizes the adjustments until you change them.

Before you start, remember...

- Make sure that you have set the speaker information correctly (see page 11).
- There is a time limit in doing the following steps. If the setting is canceled before you finish, start from step 1 again.
- You can only adjust the rear and/or center speaker output levels when you have connected rear speakers and/or a center speaker and have set "REAR SPK" and/or "CNTR SPK" correctly. See page 11.

On the front panel:

1. Press DVD MULTI.



Note:

When you select "DVDMULTI" as the source to play, the DSP mode is canceled temporarily, and the SURROUND button does not work.

2. Select the analog discrete output mode on the DVD player, and start playing a DVD.

- Refer to the manual supplied with the DVD player.

If you need to make any adjustment, go to the following steps.

3. Press ADJUST so that MULTI CURSOR $\Delta / \nabla / \triangleleft / \triangleright$ buttons work for adjusting the DVD MULTI playback setting.

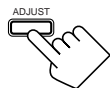

4. Press MULTI CURSOR Δ / ∇ repeatedly until "-CENTER+" appears on the display.

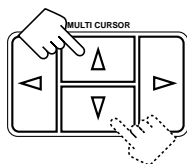

5. Press MULTI CURSOR $\triangleleft / \triangleright$ to adjust the center speaker output level (from -10 to +10).

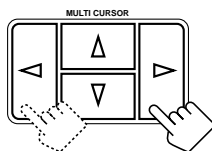

6. Press MULTI CURSOR Δ / ∇ repeatedly until "-REAR L+" appears on the display.

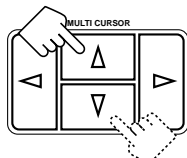

7. Press MULTI CURSOR $\triangleleft / \triangleright$ to adjust the left rear speaker output level (from -10 to +10).

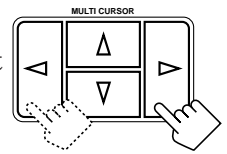

8. Press MULTI CURSOR Δ / ∇ repeatedly until "-REAR R+" appears on the display.

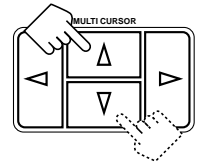

9. Press MULTI CURSOR $\triangleleft / \triangleright$ to adjust the right rear speaker output level (from -10 to +10).

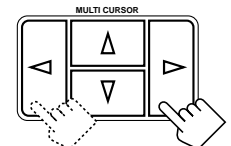

From the remote control:

1. Press DVD MULTI.

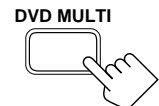

Note:

When you select "DVDMULTI" as the source to play, the DSP mode is canceled temporarily, and the SURROUND button does not work.

2. Select the analog discrete output mode on the DVD player, and start playing a DVD.

- Refer to the manual supplied with the DVD player.

If you need to make any adjustment, go to the following steps.

3. Press SOUND CONTROL.

The 10 keys are activated for adjusting the sound.

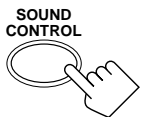

4. Press CENTER - / + to adjust the center speaker output level.

- Pressing CENTER - decreases the output level up to -10 dB.
- Pressing CENTER + increases the output level up to +10 dB.



5. Press REAR•L - / + to adjust the left rear speaker output level.

- Pressing REAR•L - decreases the output level up to -10 dB.
- Pressing REAR•L + increases the output level up to +10 dB.



6. Press REAR•R - / + to adjust the right rear speaker output level.

- Pressing REAR•R - decreases the output level up to -10 dB.
- Pressing REAR•R + increases the output level up to +10 dB.



COMPU LINK Remote Control System

The COMPU LINK remote control system allows you to operate JVC audio components through the remote sensor on the receiver.

To use this remote control system, you need to connect JVC audio components through the COMPU LINK-3 (SYNCHRO) jacks (see below) in addition to the connections using cables with RCA pin plugs (see page 5).

- Make sure that the AC power cords of these components are unplugged before connection. Plug the AC power cords only after all connections are complete.

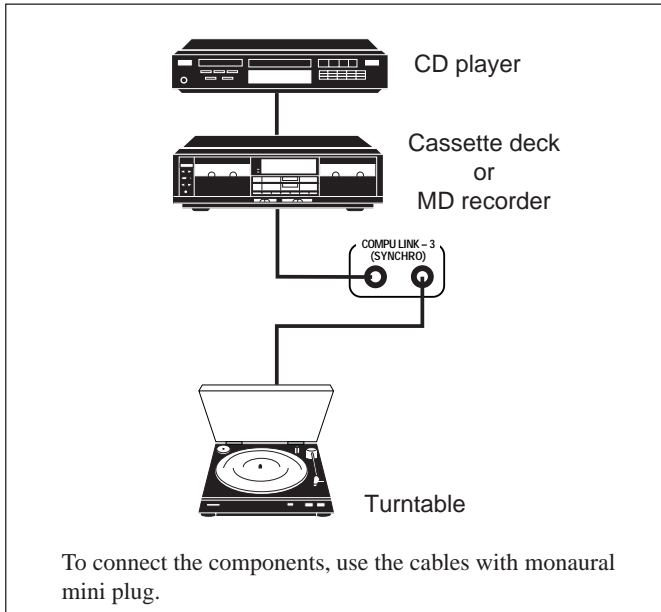

Notes:

- If your audio component has two COMPU LINK-3 (SYNCHRO) jacks, you can use either one. If it has only one COMPU LINK-3 (SYNCHRO) jack, connect it so that it is the last item in the series of components. (For example, the turntable or CD player in the diagram above.)
- To operate the cassette deck or MD recorder using the COMPU LINK remote control system, set the source name correctly. (See page 11.)
- Refer also to the manuals supplied with your audio components.

This remote control system allows you to use four functions listed below.

Remote Control through the Remote Sensor on the Receiver

You can control the connected audio components through the remote sensor on the receiver using this remote control. Aim the remote control directly at the remote sensor on the receiver. For details, see pages 22 and 23.

Automatic Source Selection

When you press the play (▶) button on a connected component or on its own remote control, the receiver automatically turns on and changes the source to the component. On the other hand, if you select a new source on the receiver or the remote control, the selected component begins playing immediately.

In both cases, the previously selected source continues playing without sound for a few seconds.

Automatic Power On/Off (Standby): only possible with the COMPU LINK-3 connection

Both the CD player and cassette deck (or MD recorder) turn on and off (standby) along with the receiver.

When you turn on the receiver, the CD player or cassette deck (or MD recorder) will turn on automatically, depending on which component has been previously selected.

When you turn off the receiver, both the CD player and cassette deck (or MD recorder) will turn off (standby).

Synchronized Recording

Synchronized recording means the cassette deck (or MD recorder) starts recording as soon as a CD or a record begins playing.

To use synchronized recording, follow these steps:

1. Put a tape in the cassette deck (or an MD in the MD recorder), and a disc in the CD player (or a record on the turntable).
2. Press the record (●) button and the pause (⏸) button on the cassette deck (or MD recorder) at the same time.

This puts the cassette deck (or MD recorder) into recording pause.

If you do not press the record (●) button and pause (⏸) button at the same time, the synchronized recording feature will not operate.

3. Press the play (▶) button on the CD player or on the turntable.

The source changes on the receiver, and as soon as play starts, the cassette deck (or MD recorder) starts recording. When the play ends, the cassette deck (or MD recorder) enters recording pause, and stops about 4 seconds later.

Notes:

- During synchronized recording, the selected source cannot be changed.
- If the power of any component is shut off during synchronized recording, the COMPU LINK remote control system may not operate properly. In this case, you must start again from the beginning.

Operating JVC's Audio/Video Components

You can operate JVC's audio and video components with this receiver's remote control, since control signals for JVC components are preset in the remote control.

IMPORTANT:

To operate JVC's audio components using this remote control:

- You need to connect JVC audio components through the COMPU LINK-3 (SYNCHRO) jacks (see page 21) in addition to the connections using cables with RCA pin plugs (see page 5).
- Aim the remote control directly at the remote sensor on the receiver.
- If you use the buttons on the front panel to choose a source, the remote control will not operate that source. To operate a source with the remote control, the source must be selected using buttons on the remote control.
- Refer also to the manuals supplied with your components.

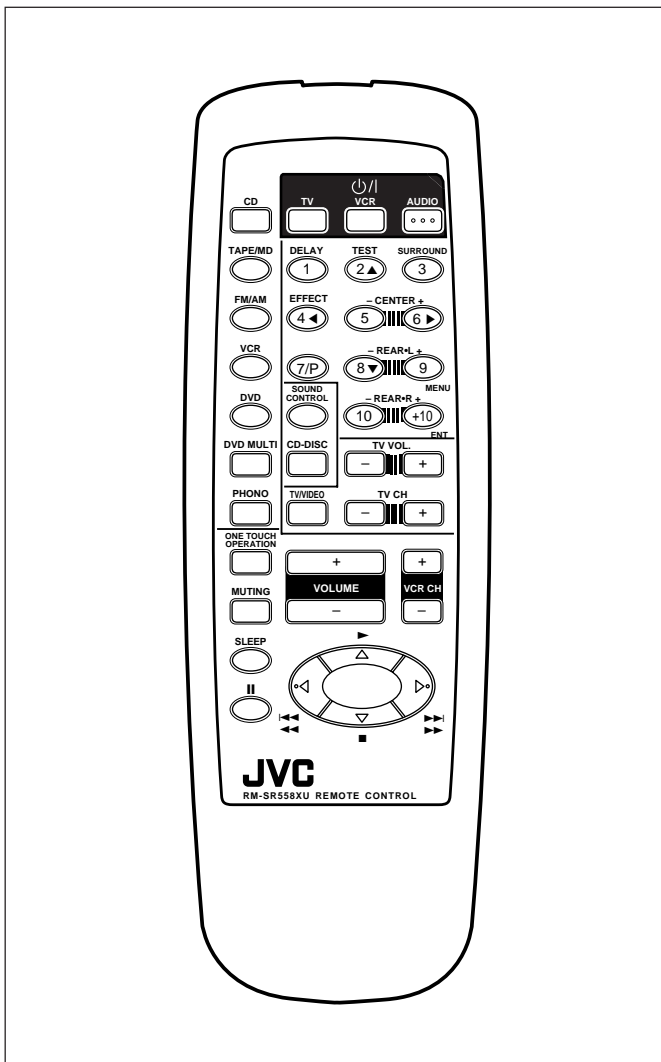

Sound control section (Amplifier)

After pressing SOUND CONTROL, you can perform the following operations:

- SURROUND:** Selects the DSP modes.
- CENTER - / +:** Adjusts the center speaker output level for the Surround/DVD MULTI playback modes.
- REAR•L - / +:** Adjusts the left/right rear speaker output level for the DSP modes.
Adjusts the left rear speaker output level for the DVD MULTI playback mode.
- REAR•R - / +:** Adjusts the right rear speaker output level for the DVD MULTI playback mode.
- DELAY:** Selects the delay time of the rear speaker sound. (Only works when "PROLOGIC" is selected.)
- EFFECT:** Selects the effect level for the DSP modes.
- TEST:** Turns on or off the test tone output for the Surround mode.

Note:

After adjusting sounds, press the corresponding source selecting button or CD-DISC to operate your target source by using the 10 keys; otherwise, the 10 keys cannot be used for operating your target source.

Cassette deck

After pressing TAPE/MD, you can perform the following operations on a cassette deck:

- ▶: Starts playing.
- ◀◀: Fast winds the tape from right to left.
- ▶▶: Fast winds the tape from left to right.
- : Stops operations.
- ||: Pauses playing. To release it, press ▶.

Note:

To operate the cassette deck or MD recorder using the COMPU LINK remote control system, set the source name correctly. (See page 11.)

CD player

After pressing CD, you can perform the following operations on the CD player:

- ▶: Starts playing.
- ◀◀: Returns to the beginning of the current (or previous) track.
- ▶▶: Skips to the beginning of the next track.
- : Stops playing.
- ||: Pauses playing. To release it, press ▶.
- 1 - 10, +10: Selects a track number directly.
For track number 5, press 5.
For track number 15, press +10, then 5.
For track number 20, press +10, then 10.

Tuner

After pressing FM/AM, you can perform the following operations:

- FM/AM:** Alternates between FM and AM.
- 1 - 10, +10:** Selects a preset channel number directly.
For channel number 5, press 5.
For channel number 15, press +10, then 5.
For channel number 20, press +10, then 10.

CD player-changer

After pressing CD-DISC, you can perform the following operations on a CD player-changer:

- ▶: Starts playing.
- ◀◀: Returns to the beginning of the current (or previous) track.
- ▶▶: Skips to the beginning of the next track.
- : Stops playing.
- ||: Pauses playing. To release it, press ▶.
- 1 – 6, 7/P: Selects the number of a disc installed in a CD player-changer.

After pressing CD, you can perform the following operations on the CD player-changer:

- 1 – 10, +10: Selects a track number directly.
For track number 5, press 5.
For track number 15, press +10, then 5.
For track number 20, press +10, then 10.

MD recorder

After pressing TAPE/MD, you can perform the following operations on the MD recorder:

- ▶: Starts playing.
- ◀◀: Returns to the beginning of the current (or previous) track.
- ▶▶: Skips to the beginning of the next track.
- : Stops playing.
- ||: Pauses playing. To release it, press ▶.

Note:

To operate the cassette deck or MD recorder using the COMPU LINK remote control system, set the source name correctly. (See page 11.)

IMPORTANT:

To operate JVC's video components using this remote control:

- Aim the remote control directly at the remote sensor on the VCR, DVD player or TV, not on the receiver.
- Some JVC VCRs can accept two types of the control signals — remote code "A" and "B." Before using this remote control, make sure that the remote control code of the VCR connected to the VCR jacks is set to code "A."

VCR

You can always perform the following operations :

VCR $\odot/|$: Turns on or off the VCR.

VCR CH +/-: Changes the channels on the VCR.

After pressing VCR, you can perform the following operations on the VCR:

- ▶: Starts playing.
- ◀◀: Rewinds a tape.
- ▶▶: Fast winds a tape.
- : Stops operations.
- ||: Pauses playing. To release it, press ▶.

DVD player

After pressing DVD or DVD MULTI, you can perform the following operations on a DVD player:

- ▶: Starts playing.
- ◀◀: Returns to the beginning of the current (or previous) track.
- ▶▶: Skips to the beginning of the next track.
- : Stops playing.
- ||: Stops playing temporarily. To release it, press ▶.

After pressing DVD or DVD MULTI, these buttons can be used for the DVD menu operations.

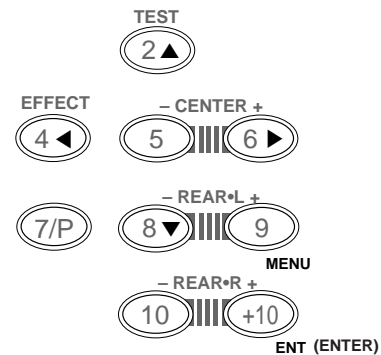
**Note:**

For detailed menu operations, refer to the instructions supplied with the discs or the DVD player.

TV

You can always perform the following operations:

TV $\odot/|$: Turns on or off the TV.

TV VOL. +/-: Adjusts the volume.

TV/VIDEO: Sets the input mode (either TV or VIDEO).

TV CH +/-: Changes the channels.

Troubleshooting

Use this chart to help you solve daily operational problems. If there is any problem you cannot solve, contact your JVC service center.

PROBLEM	POSSIBLE CAUSE	SOLUTION
The display does not light up.	The power cord is not plugged in.	Plug the power cord into an AC outlet.
No sound from speakers.	Speaker signal cables are not connected.	Check speaker wiring and reconnect if necessary.
	The SPEAKERS 1 and 2 buttons are not set correctly.	Press SPEAKERS 1 and 2 correctly.
	An incorrect source is selected.	Select the correct source.
	Muting is activated.	Press MUTING to cancel the mute.
Sound from one speaker only.	Speaker signal cables are not connected properly.	Check speaker wiring and reconnect if necessary.
	The balance is set to one extreme.	Adjust the balance properly (see page 9).
Continuous hiss or buzzing during FM reception.	Incoming signal is too weak.	Connect an outside FM antenna or contact your dealer.
	The station is too far away.	Select a new station.
	An incorrect antenna is used.	Check with your dealer to be sure you have the correct antenna.
	Antennas are not connected properly.	Check connections.
Occasional cracking noise during FM reception.	Ignition noise from automobiles.	Move the antenna farther from automobile traffic.
Howling during record playing.	Your turntable is too close to speakers.	Move speakers away from the turntable.
"OVERLOAD" starts flashing on the display.	Speakers are overloaded because of high volume.	Rotate the MASTER VOLUME control counterclockwise three or four times, then press STANDBY/ON (⏻) on the front panel. If "OVERLOAD" does not disappear, unplug the AC power cord, then plug it back again.
	Speakers are overloaded because of short circuit of speaker terminals.	Press STANDBY/ON (⏻) on the front panel, then check the speaker wiring. If "OVERLOAD" does not disappear, unplug the AC power cord, then plug it back again. If speaker wiring is not short-circuited, contact your dealer.
Remote control does not work.	There is an obstruction in front of the remote sensor on the receiver.	Remove the obstruction.
	Batteries are weak.	Replace batteries.

Amplifier

Output Power

At Stereo operation: 100 W per channel, min. RMS, both channels driven into 8 Ω at 1 kHz, with no more than 0.9% total harmonic distortion. (IEC268-3/DIN)

At Surround operation:

Front Channel: 70 W per channel, min. RMS, driven into 8 Ω at 1 kHz, with no more than 0.8% total harmonic distortion.

Center channel: 70 W, min. RMS, driven into 8 Ω at 1 kHz, with no more than 0.8% total harmonic distortion.

Rear channel: 70 W per channel, min. RMS, driven into 8 Ω at 1 kHz, with no more than 0.8% total harmonic distortion.

Total Harmonic Distortion (8 Ω , 1 kHz):

0.8%* at 100 W output

(* Measured by JVC Audio Analysis System)

Audio

Audio Input Sensitivity/Impedance (1 kHz):

PHONO (MM): 2.7 mV/47 k Ω

CD, TAPE/MD, VCR, DVD:
220 mV/47 k Ω

Audio Output Level: TAPE/MD, VCR 220 mV

Signal-to-Noise Ratio ('66 IHF/DIN):

PHONO: 70 dB/66 dB

CD, TAPE/MD, VCR, DVD:
87 dB/67 dB

Frequency Response (8 Ω):

PHONO: 20 Hz to 20 kHz (± 1 dB)

CD, TAPE/MD, VCR, DVD:
20 Hz to 20 kHz (± 1 dB)

RIAA Phono Equalization: ± 1.0 dB (20 Hz to 20 kHz)

Video

Video Input Sensitivity/Impedance:

VCR, DVD: 1V(p-p)/75 Ω

Video Output Level:

VCR, MONITOR OUT: 1V(p-p)/75 Ω

Synchronization: Negative

Signal-to-Noise Ratio: 45 dB

FM tuner (IHF)

Tuning Range: 87.50 MHz to 108.00 MHz

Usable Sensitivity: Monaural: 12.8 dBf (1.20 μ V/75 Ω)

50 dB Quieting Sensitivity:

Monaural: 21.3 dBf (3.2 μ V/75 Ω)

Stereo: 41.3 dBf (31.5 μ V/75 Ω)

Signal-to-Noise Ratio (IHF-A weighted):

Monaural: 78 dB at 85 dBf

Stereo: 73 dB at 85 dBf

Total Harmonic Distortion:

Monaural: 0.4% at 1 kHz

Stereo: 0.6% at 1 kHz

Stereo Separation at REC OUT: 35 dB at 1 kHz

Alternate Channel Selectivity:

45 dB: (\pm 400 kHz)

Frequency Response: 30 Hz to 15 kHz: (+0.5 dB, -3 dB)

AM tuner

Tuning Range: 531 kHz to 1,602 kHz (at 9 kHz interval)
530 kHz to 1,600 kHz (at 10 kHz interval)

Usable Sensitivity: Loop antenna 400 μ V/m

Signal-to-Noise Ratio: 50 dB (100 mV/m)

General

Power Requirements: AC 220 V \sim ,
adjustable with the voltage selector,
50 Hz

Power Consumption: 250 W (at operation)
5 W (in standby mode)

Dimensions (W x H x D): 435 mm x 146 mm x 403.5 mm
(17 ³/₁₆ in. x 5 ³/₄ in. x 15 ¹⁵/₁₆ in.)

Mass: 10.2 kg (22.5 lbs)

Designs & specifications are subject to change without notice.

Mains (AC) Line Instruction (not applicable for Europe, U.S.A., Canada, Australia and U.K.)

Instrucción sobre la línea de la red (CA) (no aplicable para Europa, EE.UU., Canadá, Australia, ni el Reino Unido)

Instrução sobre a tensão da rede eléctrica (CA) (não aplicável para a Europa, os E.U.A., o Canadá, a Austrália e o Reino Unido)

主 (AC) 电源线路说明 (不适用于欧洲、美国、加拿大、澳洲及英国型号)

تعليمات التيار الرئيسي (التردد) (لا ينطبق لأوروبا وأمريكا وكندا وأستراليا والمملكة المتحدة)

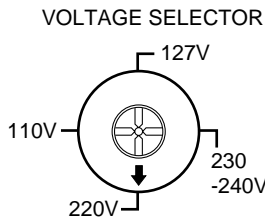
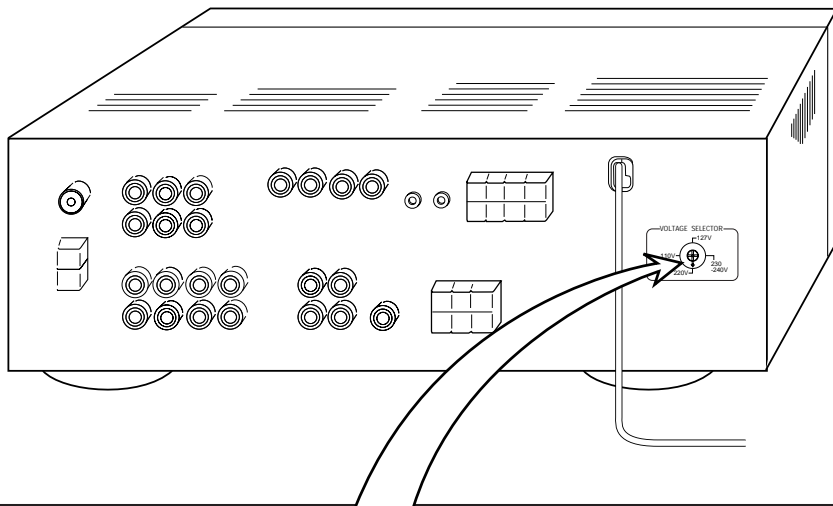

CAUTION for mains (AC) line

BEFORE PLUGGING IN, do check that your mains (AC) line voltage corresponds with the position of the voltage selector switch provided on the outside of this equipment and, if different, reset the voltage selector switch, to prevent from a damage or risk of fire/electric shock.

PRECAUCIÓN para la línea de la red (CA)

ANTES DE ENCHUFAR EL EQUIPO, compruebe si la tensión de la línea de la red (CA) corresponde con la posición del selector de tensión situado en la parte exterior del equipo, y si es diferente, reajuste el selector de tensión para evitar el riesgo de incendios/ descargas eléctricas.

PRECAUÇÃO para a ligação à tensão da rede (CA)

ANTES DE LIGAR O APARELHO A UMA TOMADA DA REDE, verifique se a tensão da rede CA corresponde à posição do selector de voltagem localizado na parte externa deste equipamento. Caso não corresponda, reajuste o selector de voltagem a fim de evitar avarias ou riscos de incêndio e choque eléctrico.

有关主(AC)电源线路的注意事项

接插电源以前，务请检查当地的主 (AC) 电源线路电压是否和位于本机外面的电压选择开关设定的位置一致。如果不一致，即重新设定电压选择开关使符合当地电压，以免损坏机器或引起火灾/触电的危险。

هام من أجل خط التيار المتردد (AC) الرئيسي

قبل ادخال القابس، تأكد من أن فولتية خط التيار المتردد (AC) الرئيسي لديك متوافقة مع موضع مفتاح اختيار الفولتية المتوفر خارج هذه المعدات وإذا اختلفت، فقم باعادة ضبط مفتاح اختيار الفولتية، لمنع التلف أو الصدمة الكهربائية وخطر الحريق.

JVC

VICTOR COMPANY OF JAPAN, LIMITED